

Duo 4' x 6'
PRISM 2424 // Agencement PRIP-D8

DUO d'Artofix met en valeur votre espace tout en améliorant l'acoustique. Son installation est facile grâce ses agencements prédéfinis sans tracas et son design élégant. Laissez-vous inspirer par les suggestions d'agencements.

MODÈLES DE TUILES OFFERTS :



Crystal
24 x 24 po
610 x 610 mm

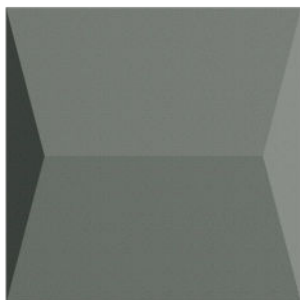

Prism
24 x 24 po
610 x 610 mm

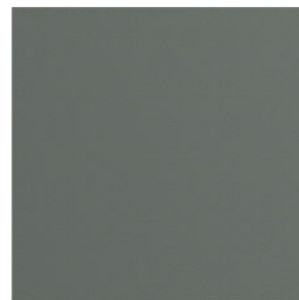

Zen
24 x 24 po
610 x 610 mm

DUO

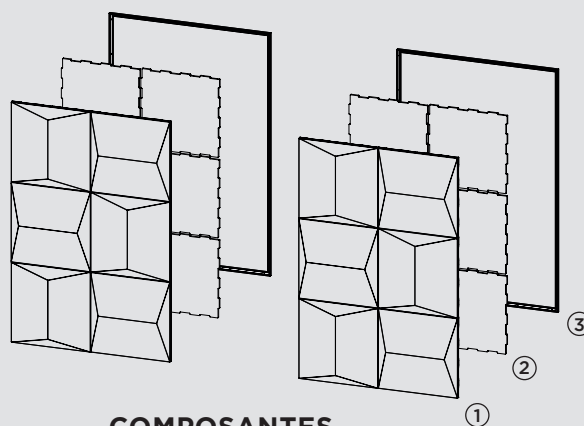
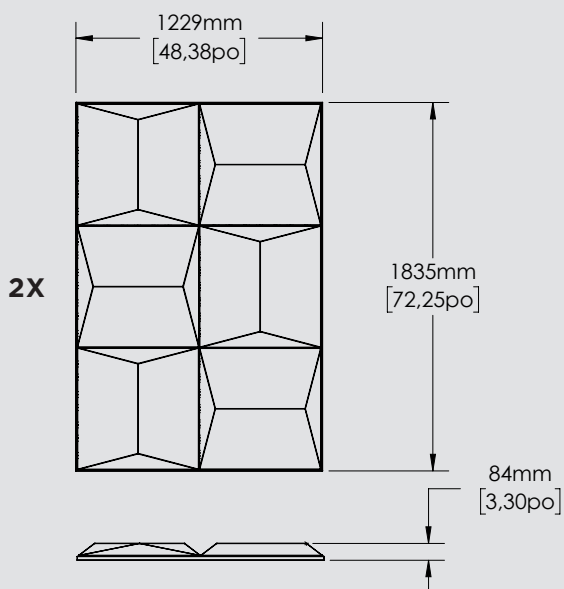

FORMAT 4' X 6'



COMPOSANTES

- ① Tuiles
- ② Doublure acoustique (laine de roche)
- ③ Moulures pré-coupées Artotrim-C1 (aluminium anodisé)

INFORMATIONS SUR LE PRODUIT

	Modèle	Dimensions L x H	Épaisseur	Surface acoustique	Codes DUO [†]	Artotrim-C1* (incluses)	Artoclips** (incluses)
	Crystal Duo 4 x 6 (12 tuiles)	2 cadres de : 48,38 x 72,25 po 1229 x 1835 mm	4,02 po 102 mm	48 pi ² 4,46 m ²	CRYP-4872-R-D-2335-****	4x (48 po) 4x (72 po)	40
	Prism Duo 4 x 6 (12 tuiles)	2 cadres de : 48,38 x 72,25 po 1229 x 1835 mm	3,30 po 84 mm	48 pi ² 4,46 m ²	PRIP-4872-R-D-2335-****	4x (48 po) 4x (72 po)	40
	Zen Duo 4 x 6 (12 tuiles)	2 cadres de : 48,38 x 72,25 po 1229 x 1835 mm	0,93 po 24 mm	48 pi ² 4,46 m ²	ZENP-4872-R-D-2335-****	4x (48 po) 4x (72 po)	40

CHOIX DE TISSUS

Style Ancre 2335



White
2664

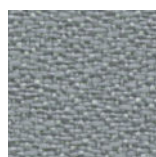

Slate
2017



Asteroid
2053

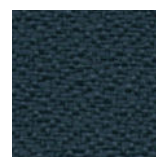

Deep Water
2051

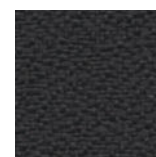

Graphite
2079

† Tissus

Remplacer **** par le numéro de couleur sélectionné

* Moulures de périmètre pré-coupées

** Clips de rétention pour tuiles au périmètre du cadre

TISSUS ANCHORAGE

Ancre 2335
65 % de polyester recyclé pré-consommation
35 % de polyester recyclé post-consommation

INFLAMMABILITÉ

ASTM-E-84
CAN/ULC-S102.2

PERFORMANCE ACOUSTIQUE**

Coefficient de réduction du bruit (Hz)
CRB (NRC) 0.80

DUO

FORMAT 4' X 6'

AGENCEMENT DES TUILES

Crystal

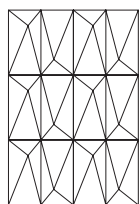

CRYP-D1

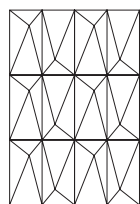

CRYP-D2

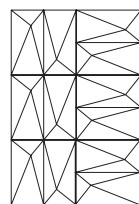

CRYP-D3

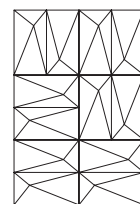
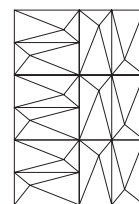

CRYP-D4

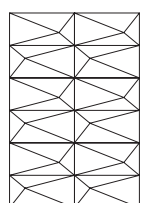
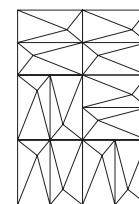

CRYP-D5

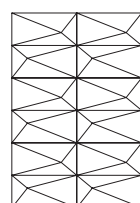

CRYP-D6

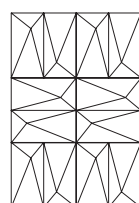

CRYP-D7

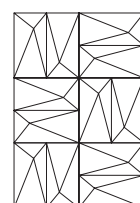
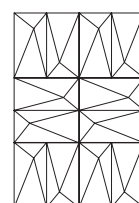

CRYP-D8

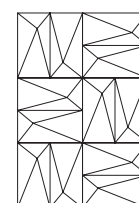

Prism

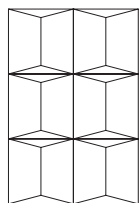

PRIP-D1

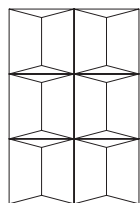

PRIP-D2

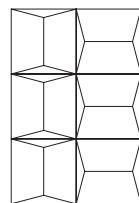

PRIP-D3

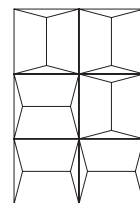
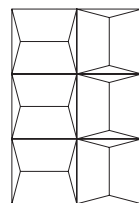

PRIP-D4

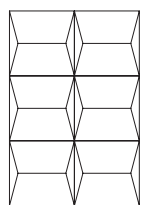
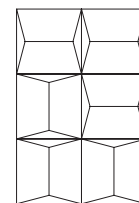

PRIP-D5

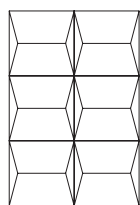

PRIP-D6

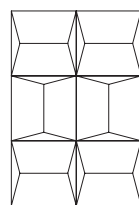

PRIP-D7

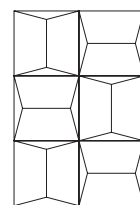
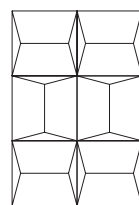

PRIP-D8

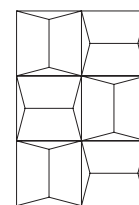

Zen

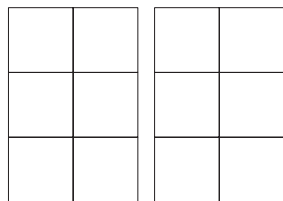

ZENP-D1

Pour obtenir plus de détails sur les produits, vous pouvez nous contacter ou joindre un distributeur local autorisé.

**Les résultats proviennent d'un laboratoire indépendant certifié et ont été effectués selon les normes ASTM C423-09a. Méthode d'essai standard pour les coefficients d'absorption acoustique par la méthode en salle de réverbération. Pratique standard ASTM E795 pour le montage d'échantillons de test pendant les tests d'absorption acoustique.

Les dessins ne sont pas à l'échelle. Ne pas utiliser comme gabarit. Les informations contenues dans cette mise en plan sont la propriété d'Artofix. Reproduction interdite.

FICHE PRODUIT_2023-11

+1.450.646.7555
info@artofix.com

artofix.com