



Duo 4' x 6'
PRISM 2424 // Layout PRIP-D8

DUO from Artofix enhance your space while improving acoustics. Its predefined layouts make for hassle-free installation, as does its elegant design. Get inspired by the different configurations.

AVAILABLE TILE MODELS :



Crystal
24 x 24 in
610 x 610 mm

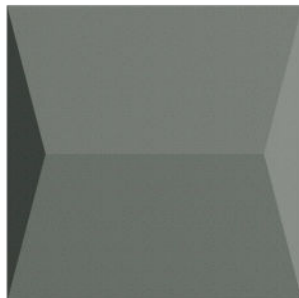

Prism
24 x 24 in
610 x 610 mm



Zen
24 x 24 in
610 x 610 mm

DUO

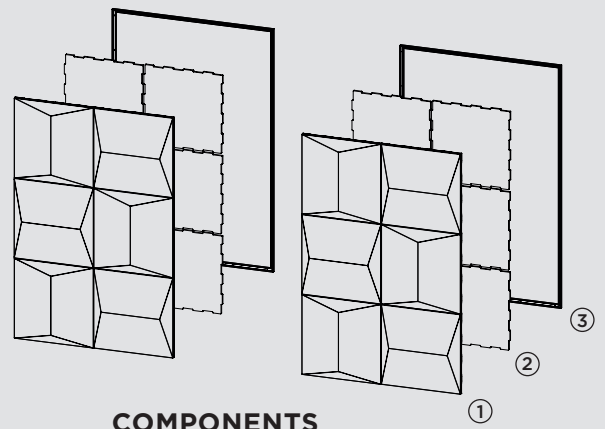
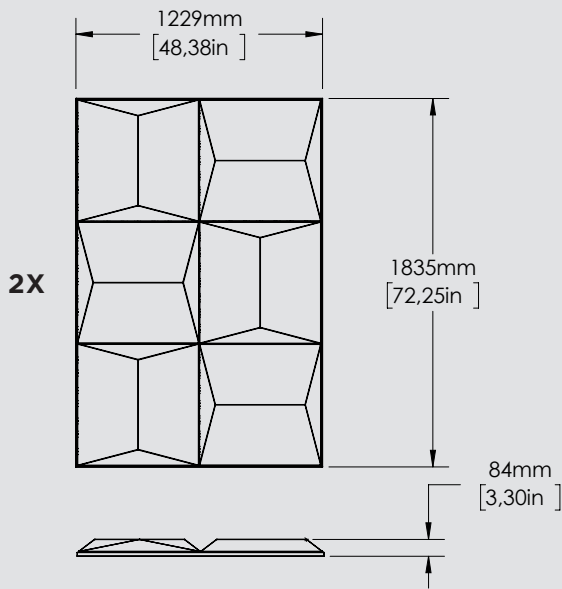

FORMAT 4' X 6'



COMPONENTS

- ① Tiles
- ② Acoustics Lining (stone wool)
- ③ Artotrim-C1 pre-cut moldings (anodized aluminum)

PRODUCT INFORMATION

	Model	Dimensions W x H	Thickness	Acoustic Surface Area	Codes DUO [†]	Artotrim-C1* (included)	Artoclips** (included)
	Crystal Duo 4 x 6 (12 tiles)	2 frames : 48,38 x 72,25 in 1229 x 1835 mm	4,02 in 102 mm	48 ft ² 4,46 m ²	CRYP-4872-R-D-2335-****	4x (48 in) 4x (72 in)	40
	Prism Duo 4 x 6 (12 tiles)	2 frames : 48,38 x 72,25 in 1229 x 1835 mm	3,30 in 84 mm	48 ft ² 4,46 m ²	PRIP-4872-R-D-2335-****	4x (48 in) 4x (72 in)	40
	Zen Duo 4 x 6 (12 tiles)	2 frames : 48,38 x 72,25 in 1229 x 1835 mm	0,93 in 24 mm	48 ft ² 4,46 m ²	ZENP-4872-R-D-2335-****	4x (48 in) 4x (72 in)	40

CHOICE OF FABRICS

Anchorage Fabric 2335



White
2664

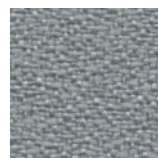

Slate
2017



Asteroid
2053

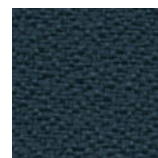

Deep Water
2051

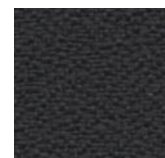

Graphite
2079

†Fabrics

Replace **** by the color number

*Pre-cut perimeter moldings

**Tile retention clips at frame perimeter

ANCHORAGE FABRICS

Anchorage 2335
65% pre-consumer recycled polyester
35% post-consumer recycled polyester

FLAMMABILITY

ASTM-E-84
CAN/ULC-S102.2

ACOUSTIC PERFORMANCE***

Noise Reduction Coefficient (Hz)
NRC 0.80

FORMAT 4' X 6'

TILE LAYOUT

Crystal

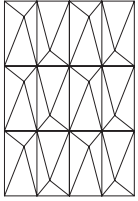

CRYP-D1

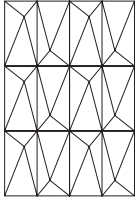

CRYP-D2

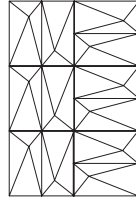

CRYP-D3

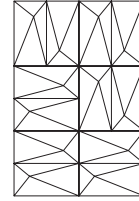
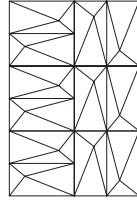

CRYP-D4

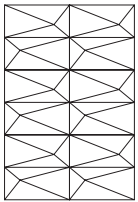
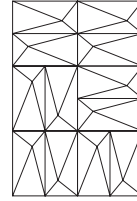

CRYP-D5

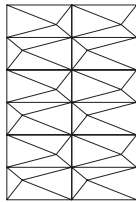

CRYP-D6

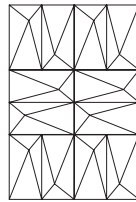

CRYP-D7

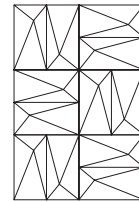
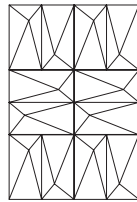

CRYP-D8

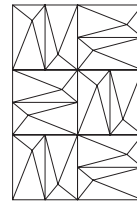

Prism

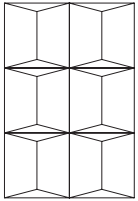

PRIP-D1

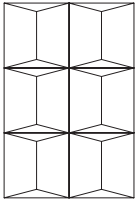

PRIP-D2

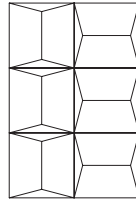

PRIP-D3

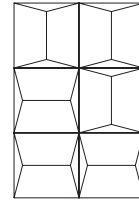
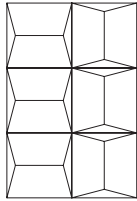

PRIP-D4

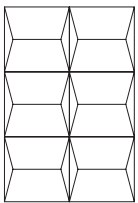
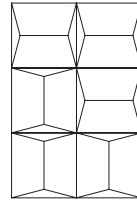

PRIP-D5

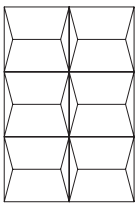

PRIP-D6

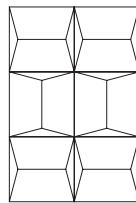

PRIP-D7

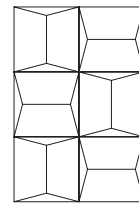
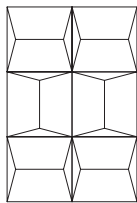

PRIP-D8

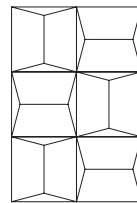

Zen

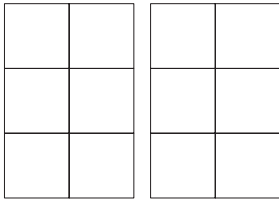

ZENP-D1

For more details on our products and possible layouts, you can contact us or reach out to an authorized local distributor.

***Results determined through testing by an independent, certified laboratory that was conducted according to industry standards. ASTM C423-09a. Standard test method for sound absorption coefficients by the reverberation room method. ASTM E795 standard practice for mounting test samples during sound absorption tests.

Drawings not to scale. Do not use as template. The information contained in this document is the property of ARTOFIX. Reproduction is prohibited.
PRODUCT SHEET_2023-11

+1.450.646.7555
info@artofix.com

artofix.com