

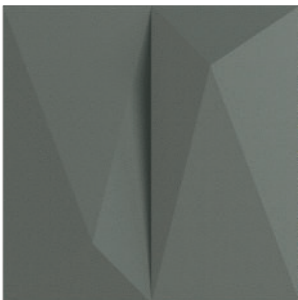

SOLO from Artofix enhance your space while improving acoustics. Its predefined layouts make for hassle-free installation, as does its elegant design. Get inspired by the different configurations.

AVAILABLE TILE MODELS :



Crystal
24 x 24 in
610 x 610 mm

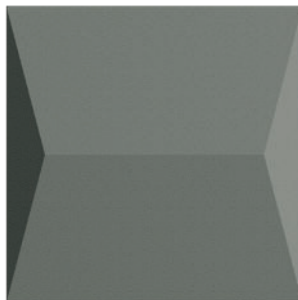

Prism
24 x 24 in
610 x 610 mm

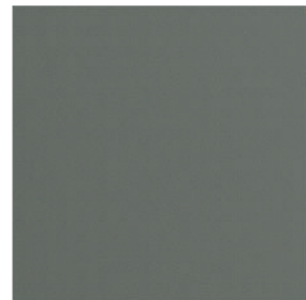

Zen
24 x 24 in
610 x 610 mm

SOLO

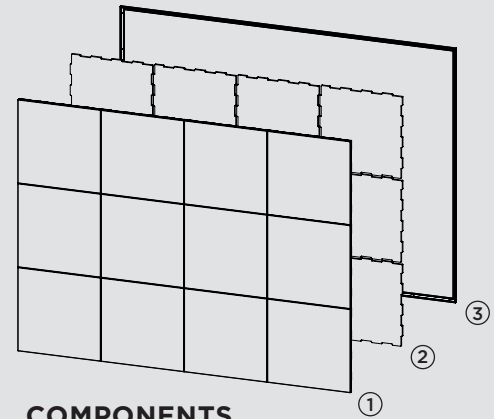
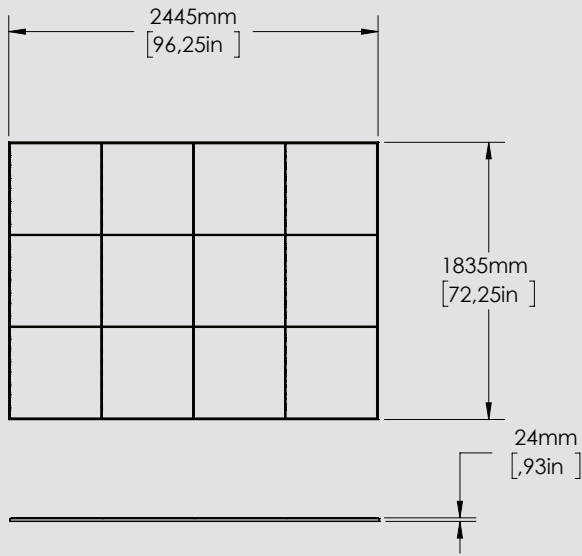

FORMAT 8' X 6'



COMPONENTS

- ① Tiles
- ② Acoustics Lining (stone wool)
- ③ Artotrim-C1 pre-cut moldings (anodized aluminum)

PRODUCT INFORMATION

	Model	Dimensions W x H	Thickness	Acoustic Surface Area	Codes SOLO [†]	Artotrim-C1* (included)	Artoclips** (included)
	Crystal Solo 6 x 8 (12 tiles)	96,25 x 72,25 in 2445 x 1835 mm	4,02 in 102 mm	48 ft ² 4,46 m ²	CRYP-9672-R-S-2335-****	2x (72 in) 2x (96 in)	28
	Prism Solo 6 x 8 (12 tiles)	96,25 x 72,25 in 2445 x 1835 mm	3,30 in 84 mm	48 ft ² 4,46 m ²	PRIP-9672-R-S-2335-****	2x (72 in) 2x (96 in)	28
	Zen Solo 6 x 8 (12 tiles)	96,25 x 72,25 in 2445 x 1835 mm	0,93 in 24 mm	48 ft ² 4,46 m ²	ZENP-9672-R-S-2335-****	2x (72 in) 2x (96 in)	28

CHOICE OF FABRICS

Anchorage Fabric 2335



White
2664

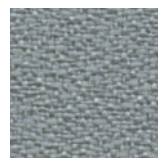

Slate
2017



Asteroid
2053

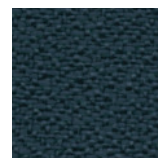

Deep Water
2051

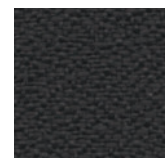

Graphite
2079

†Fabrics

Replace **** by the color number

*Pre-cut perimeter moldings

**Tile retention clips at frame perimeter

ANCHORAGE FABRICS

Anchorage 2335
65% pre-consumer recycled polyester
35% post-consumer recycled polyester

FLAMMABILITY

ASTM-E-84
CAN/ULC-S102.2

ACOUSTIC PERFORMANCE***

Noise Reduction Coefficient (Hz)
NRC 0.85 : Crystal, Prism
0.80 : Zen

SOLO

FORMAT 6' X 8'

TILE LAYOUT

Crystal

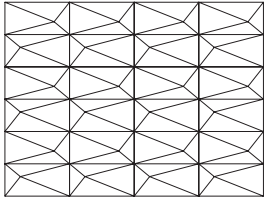

CRYP-S1

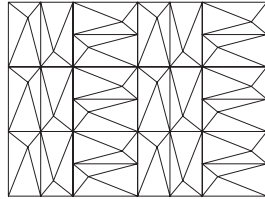

CRYP-S2

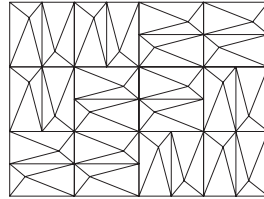

CRYP-S3

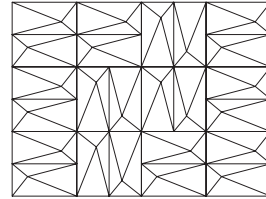

CRYP-S4

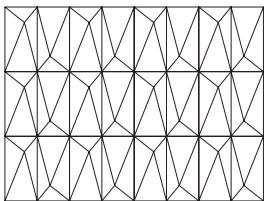

CRYP-S5

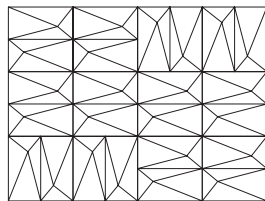

CRYP-S6

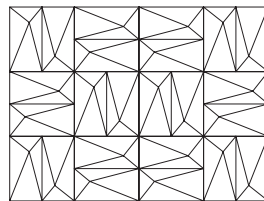

CRYP-S7

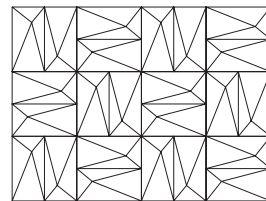

CRYP-S8

Prism

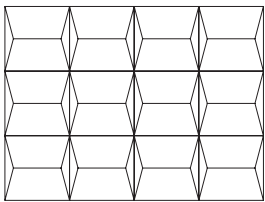

PRIP-S1

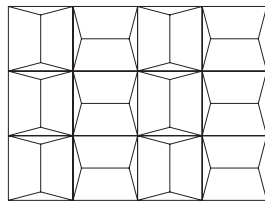

PRIP-S2

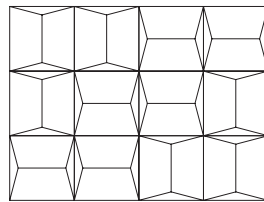

PRIP-S3

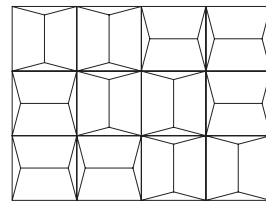

PRIP-S4

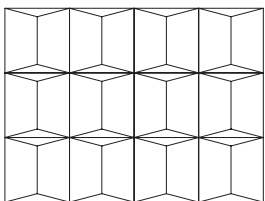

PRIP-S5

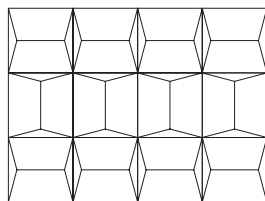

PRIP-S6

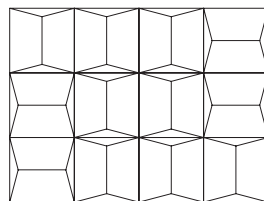

PRIP-S7

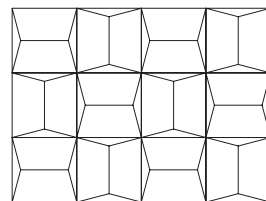

PRIP-S8

Zen

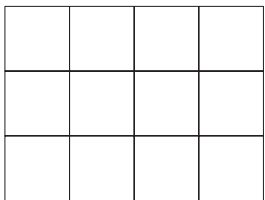

ZENP-S1

***Results determined through testing by an independent, certified laboratory that was conducted according to industry standards. ASTM C423 - Standard test method for sound absorption coefficients by the reverberation room method. See the Acoustic Performance sheet for more information.

Drawings not to scale. Do not use as template. The information contained in this document is the property of ARTOFIX. Reproduction is prohibited.

PRODUCT SHEET_2024-04

+1.450.646.7555
info@artofix.com

artofix.com