



ARTOFIX



# SUMMARY

2022-2023



01 — p. 4-5  
Our Story

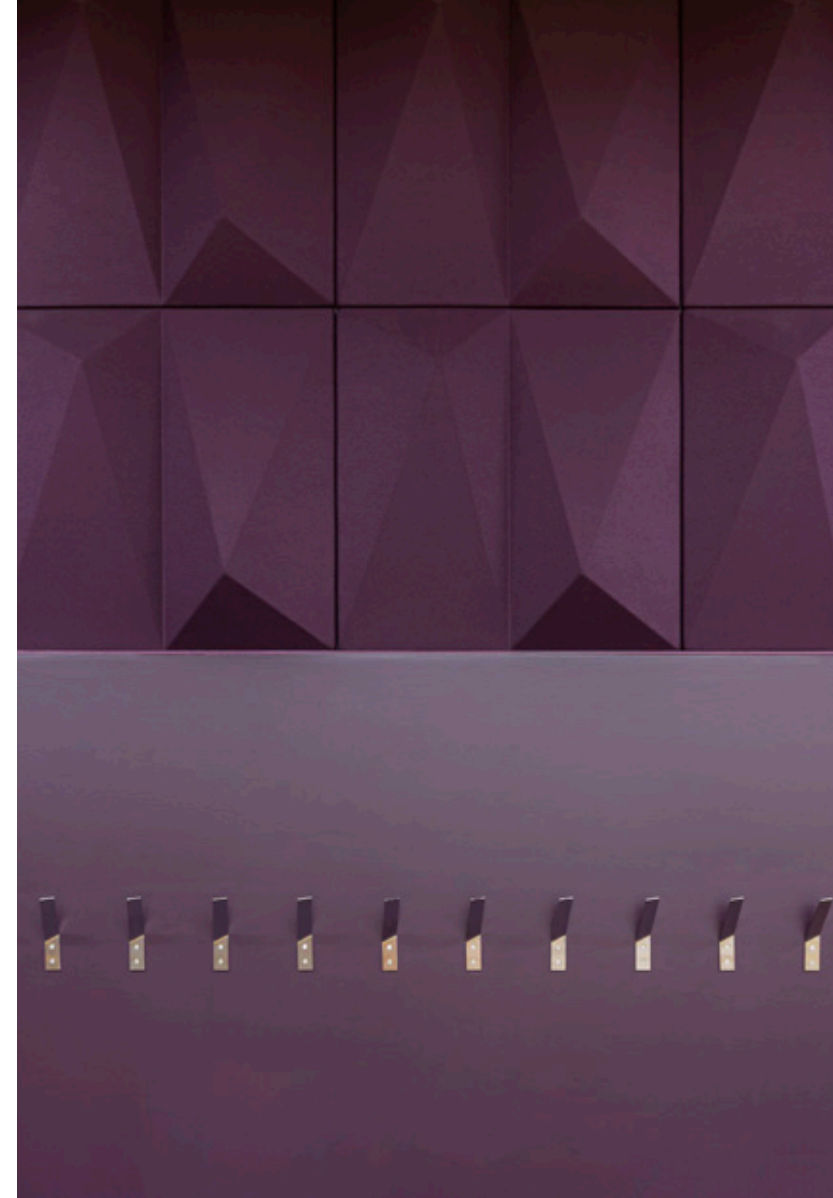

02 — p. 6-45

## Architectural Solutions

- > Architectural Tiles
- > Suspended Ceilings
- > Clouds
- > Baffles



03 — p. 46-53

## Specifications

- > Fabrics
- > Moldings



# 01

## OUR STORY

Creative collaboration

We use art to solve acoustic problems and beautify living spaces. Our solutions combine acoustic comfort with careful design to create healthy, inspiring environments that make everybody feel better. Our ultimate goal is to help our customers transform their living environments into better spaces.

Artofix delivers acoustic solutions that combine acoustic expertise with extensive experience in innovative product design.

We draw inspiration from our hometown of Montreal, a UNESCO City of Design. Our

products fuse the city's European influences with its unique architecture. Our Crystal tile (platinum award winner at the Grands Prix du Design) echoes the outline of the city's iconic Mount Royal.

At Artofix, we're always thinking about well-being and the environment. All our products are designed and manufactured in Canada with raw materials sourced from local supply chains. We use recovered materials wherever possible. And not only are Artofix products sustainable, they can also be disassembled and reused.

# ARCHITECTURAL Solutions

# 02

ARCHITECTURAL  
Solutions

## Creative freedom

Artofix has a full lineup of architectural solutions for walls and ceilings. Our tiles are available in a variety of shapes and contours, with a long list of fabric and color options. There's room for you to mix and match to create a unique layout for any project.

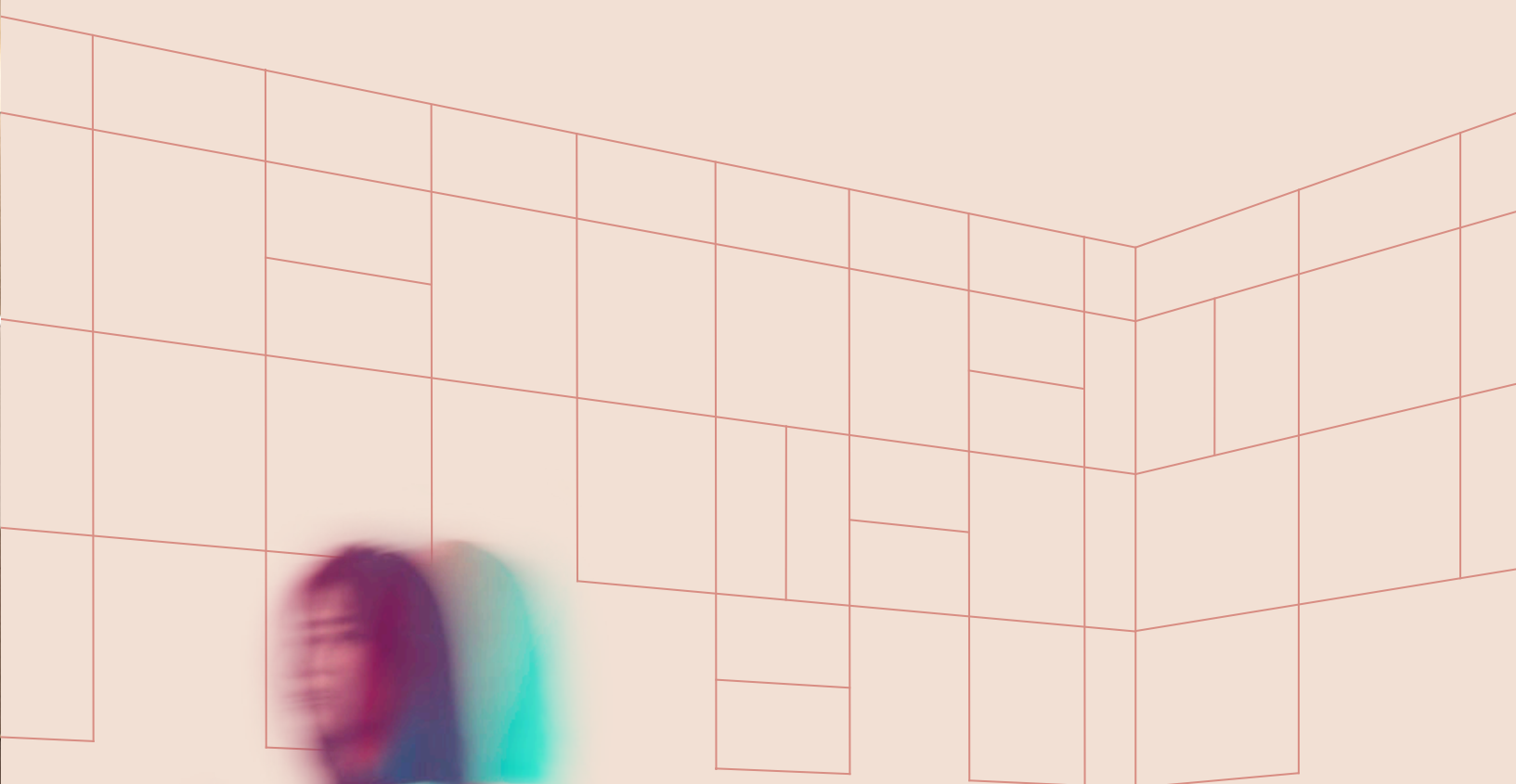

## Solutions with impact

Some of our architectural products are designed as solutions for noisy, echoey sports facilities. Tiles labelled "Sport-Impact" flex under impact and exceptionally durable when installed using our proven method.

# CRYSTAL

The outline of the Crystal tile echoes Montreal's iconic Mount Royal. Winner of the Grand Prix du Design's Platinum Award, it has a striking profile that's amplified in vertical and horizontal applications and audibly improves acoustic comfort.



Photo credit : Stéphane Groleau

## REGULAR INSTALLATION

	Dimensions W x H	Thickness	Acoustic Surface Area	Product Code*	Walls & Ceilings	Baffles**	Clouds**
	24 x 24 in 610 x 610 mm	4 in 102 mm	4 ft <sup>2</sup> 0,372 m <sup>2</sup>	CRYA-2424-R-X-****-****	●	●	●

### Perimeter Molding

	<b>Artotrim-C1</b> ARTC-1144-M-X-0000-0002	• Perimeter molding for full tiles
---	---	------------------------------------

#### \*Fabrics

Refer to the fabric offer, section 3 of the catalogue. Replace \*\*\*\*-\*\*\*\* with the fabric-style number, followed by the selected color number.

#### \*\*Baffles and Clouds

For available formats, see pages 38 to 45.

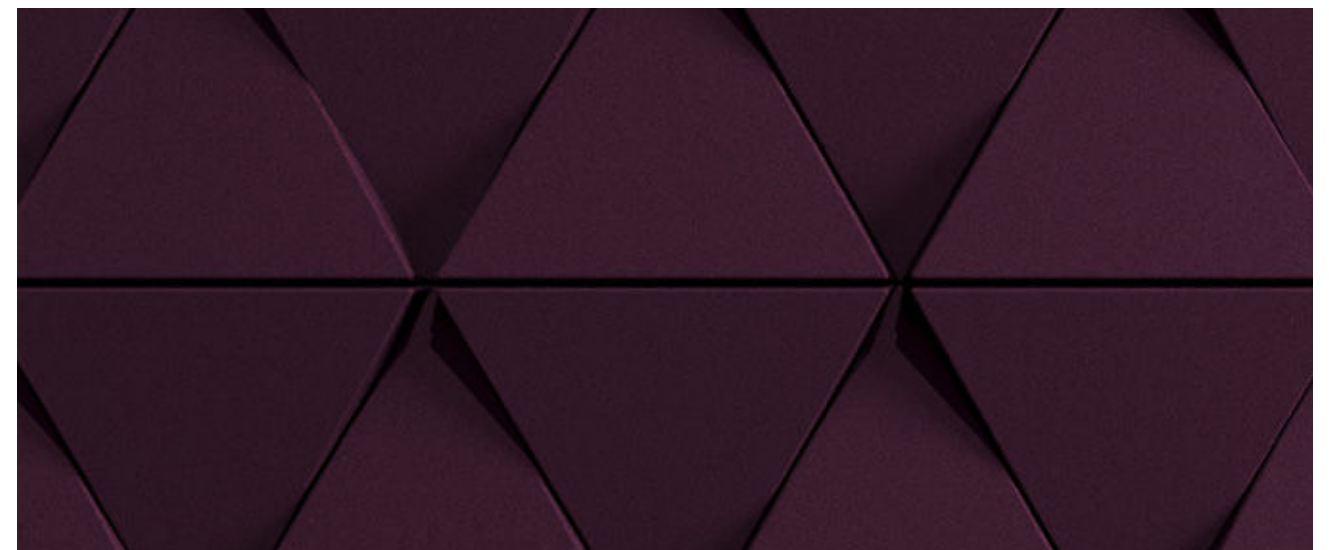
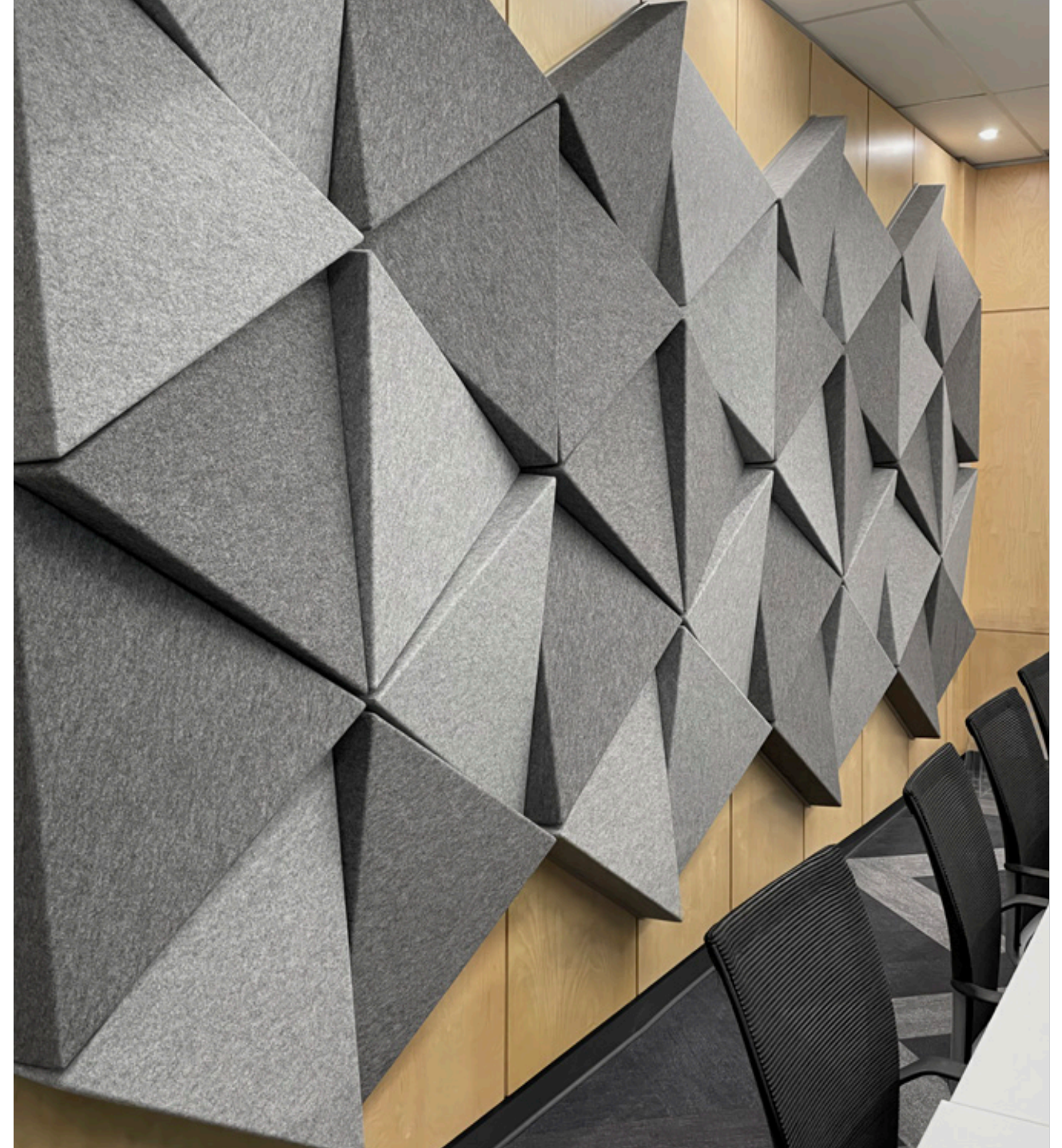
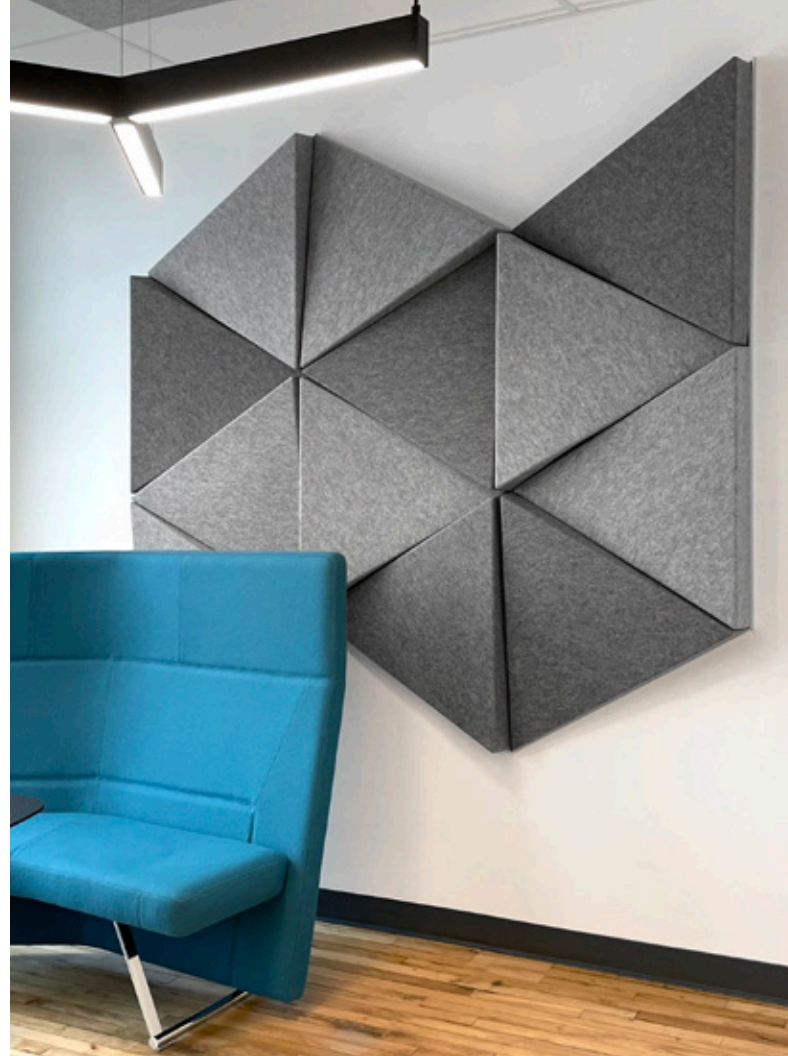

Photo credit: Stéphane Groleau



# DIAMOND

The Diamond tile's triangular shape and 3D profile create eye-catching visuals. Plus it's our most acoustically effective tile. Alternate the direction of installation to create spectacular topographies.



## REGULAR INSTALLATION

	Dimensions W x H	Thickness	Acoustic Surface Area	Product Code*	Walls & Ceilings	Baffles**	Clouds**
	30 x 26 in 762 x 660 mm	5,4 in 137 mm	2,71 ft <sup>2</sup> 0,252 m <sup>2</sup>	DIAA-3026-R-X-****-****	●	—	—

### Perimeter Molding

	<b>Artotrim-C2</b> ARTC-2144-M-X-0000-0002 • Perimeter molding for full tiles
---	--

#### \*Fabrics

Refer to the fabric offer, section 3 of the catalogue. Replace \*\*\*\*-\*\*\*\* with the fabric-style number, followed by the selected color number.

#### \*\*Baffles and Clouds

For available formats, see pages 38 to 45.

# PRISM

High-relief prism tiles make a big impact anywhere from gyms to public spaces. Play with color and alternate vertical and horizontal tiles to create dramatic visuals while putting a damper on excessive noise.



## REGULAR INSTALLATION

	Dimensions W x H	Thickness	Acoustic Surface Area	Product Code*	Walls & Ceilings	Baffles**	Clouds**
	24 x 24 in 610 x 610 mm	3,2 in 81 mm	4 ft <sup>2</sup> 0,372 m <sup>2</sup>	PRIA-2424-R-X-****-****	●	●	●



### Perimeter Molding

	<b>Artotrim-C1</b> ARTC-1144-M-X-0000-0002	• Perimeter molding for full tiles
---	---	------------------------------------

## SPORT-IMPACT INSTALLATION

	24 x 24 in 610 x 610 mm	3 in 76 mm	4 ft <sup>2</sup> 0,372 m <sup>2</sup>	PRIA-2424-S-X-****-****	●	●	●
---	----------------------------	---------------	---	-------------------------	---	---	---

### Perimeter Moldings

	<b>Artotrim-ACG</b> ARTA-0144-M-X-0000-0002	• Perimeter molding for flat tiles, allows adjustment to wall and/or ceiling • Installed with Artotrim-L1 or Artotrim-L2 plywood finishing moldings
	<b>Artotrim-L3</b> ARTL-3024-M-X-0000-0002	• 24" angle for installation with three-dimensional tiles at the perimeters, installed with the Artotrim-ACG

#### \*Fabrics

Refer to the fabric offer, section 3 of the catalogue. Replace \*\*\*\*-\*\*\*\* with the fabric-style number, followed by the selected color number.

#### \*\*Baffles and Clouds

For available formats, see pages 38 to 45.

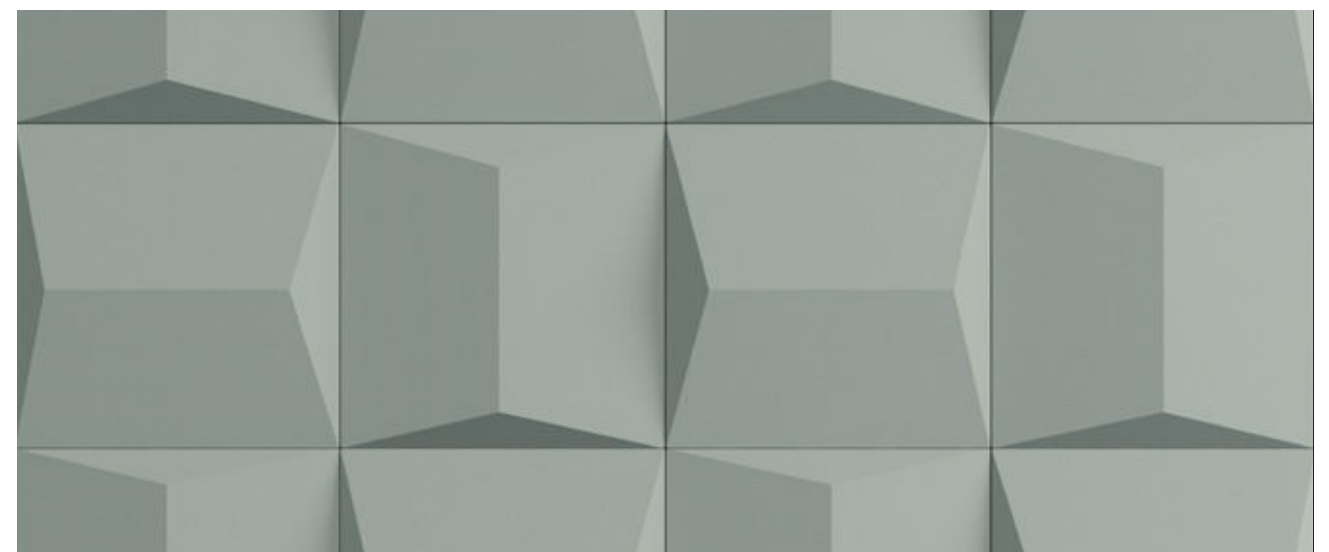

# PULSAR

Pulsar's curves add dimension while improving acoustics for a vastly more enjoyable work environment. Arrange Pulsar tiles vertically or horizontally or alternate them to get exactly the look you're going for.



## REGULAR INSTALLATION

	Dimensions W x H	Thickness	Acoustic Surface Area	Product Code*	Walls & Ceilings	Baffles**	Clouds**
	24 x 24 in 610 x 610 mm	3 in 76 mm	4 ft <sup>2</sup> 0,372 m <sup>2</sup>	PULA-2424-R-X-****-****	●	●	●

### Perimeter Molding

 **Artotrim-C1**  
ARTC-1144-M-X-0000-0002 • Perimeter molding for full tiles



#### \*Fabrics

Refer to the fabric offer, section 3 of the catalogue. Replace \*\*\*\*-\*\*\*\* with the fabric-style number, followed by the selected color number.

#### \*\*Baffles and Clouds

For available formats, see pages 38 to 45.



# PYRAMID

Need your space to sound as good as it looks? A single Pyramid may seem plain, but in a group its pyramidal shape lets you tease out fascinating shadow effects that shift with changing light—and clean up noise pollution.



## REGULAR INSTALLATION

	Dimensions W x H	Thickness	Acoustic Surface Area	Product Code*	Walls & Ceilings	Baffles**	Clouds**
☒	12 x 12 in 305 x 305 mm	1,6 in 41 mm	1 ft <sup>2</sup> 0,093 m <sup>2</sup>	PYRA-1212-R-X-****-****	●	—	—

### Perimeter Molding

 **Artotrim-C1**  
ARTC-1144-M-X-0000-0002 • Perimeter molding for full tiles

#### \*Fabrics

Refer to the fabric offer, section 3 of the catalogue. Replace \*\*\*\*-\*\*\*\* with the fabric-style number, followed by the selected color number.

#### \*\*Baffles and Clouds

For available formats, see pages 38 to 45.

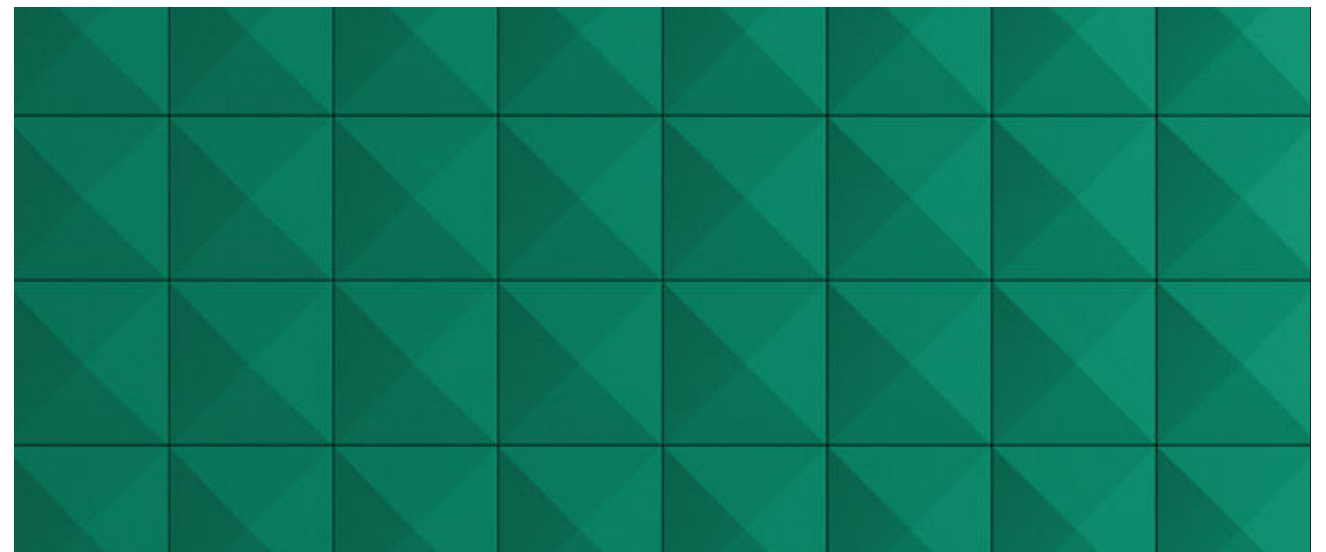
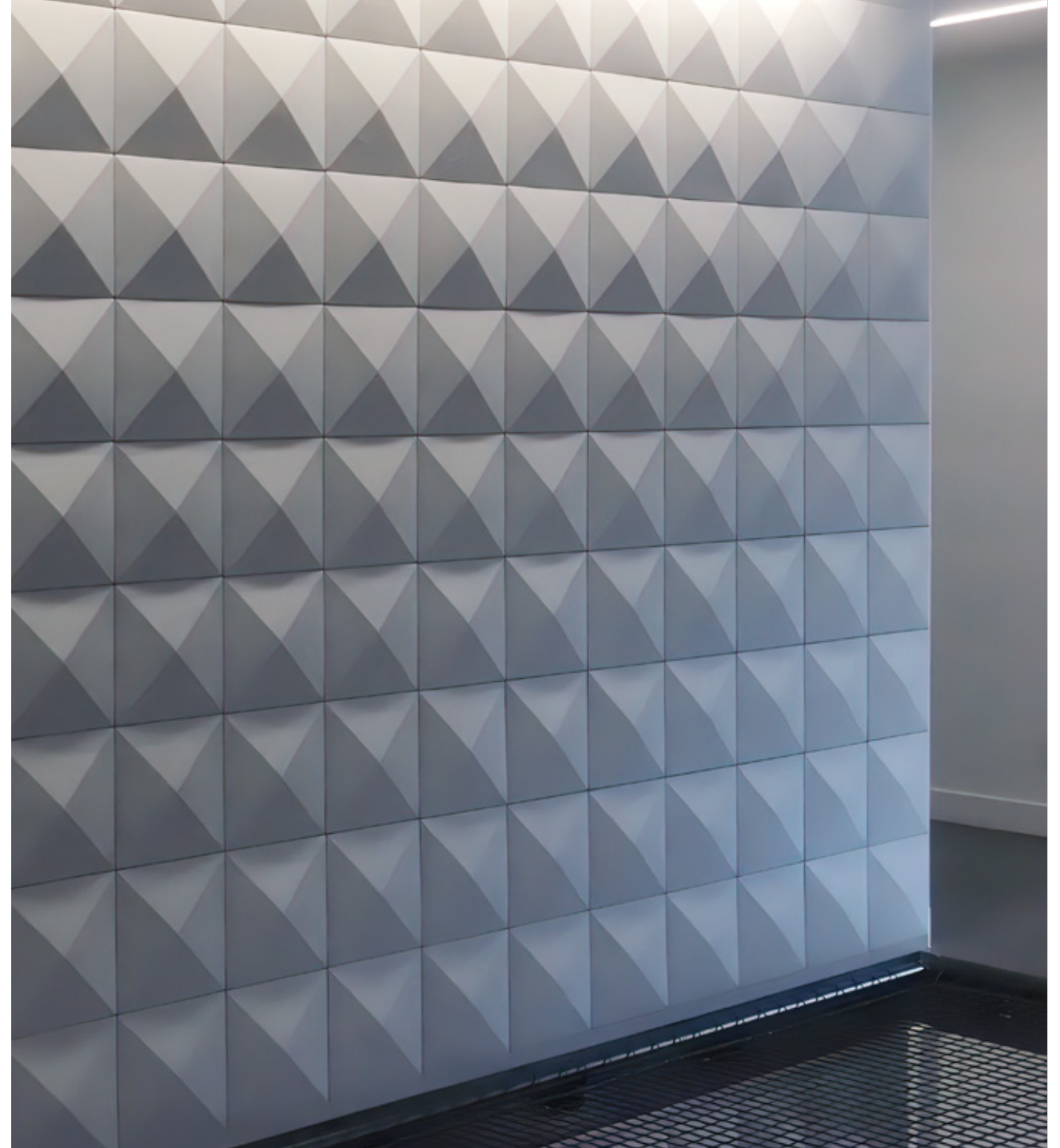

## RUBY

Rubies are a symbol of power, and this tile's asymmetrical profile adds creative potential while improving acoustics. Laid out horizontally, vertically, or in alternation, Ruby tiles give a texture and depth to walls and ceilings that varies with the brightness of the room.



## REGULAR INSTALLATION

	Dimensions W x H	Thickness	Acoustic Surface Area	Product Code*	Walls & Ceilings	Baffles**	Clouds**
	24 x 24 in 610 x 610 mm	3,4 in 86 mm	4 ft <sup>2</sup> 0,372 m <sup>2</sup>	RUBA-2424-R-X-****-****	●	●	—

## Perimeter Molding

	<b>Artotrim-C1</b> ARTC-1144-M-X-0000-0002	• Perimeter molding for full tiles
---	---	------------------------------------

**\*Fabrics**

Refer to the fabric offer, section 3 of the catalogue. Replace \*\*\*\*-\*\*\*\* with the fabric-style number, followed by the selected color number.

**\*\*Baffles and Clouds**

For available formats, see pages 38 to 45.

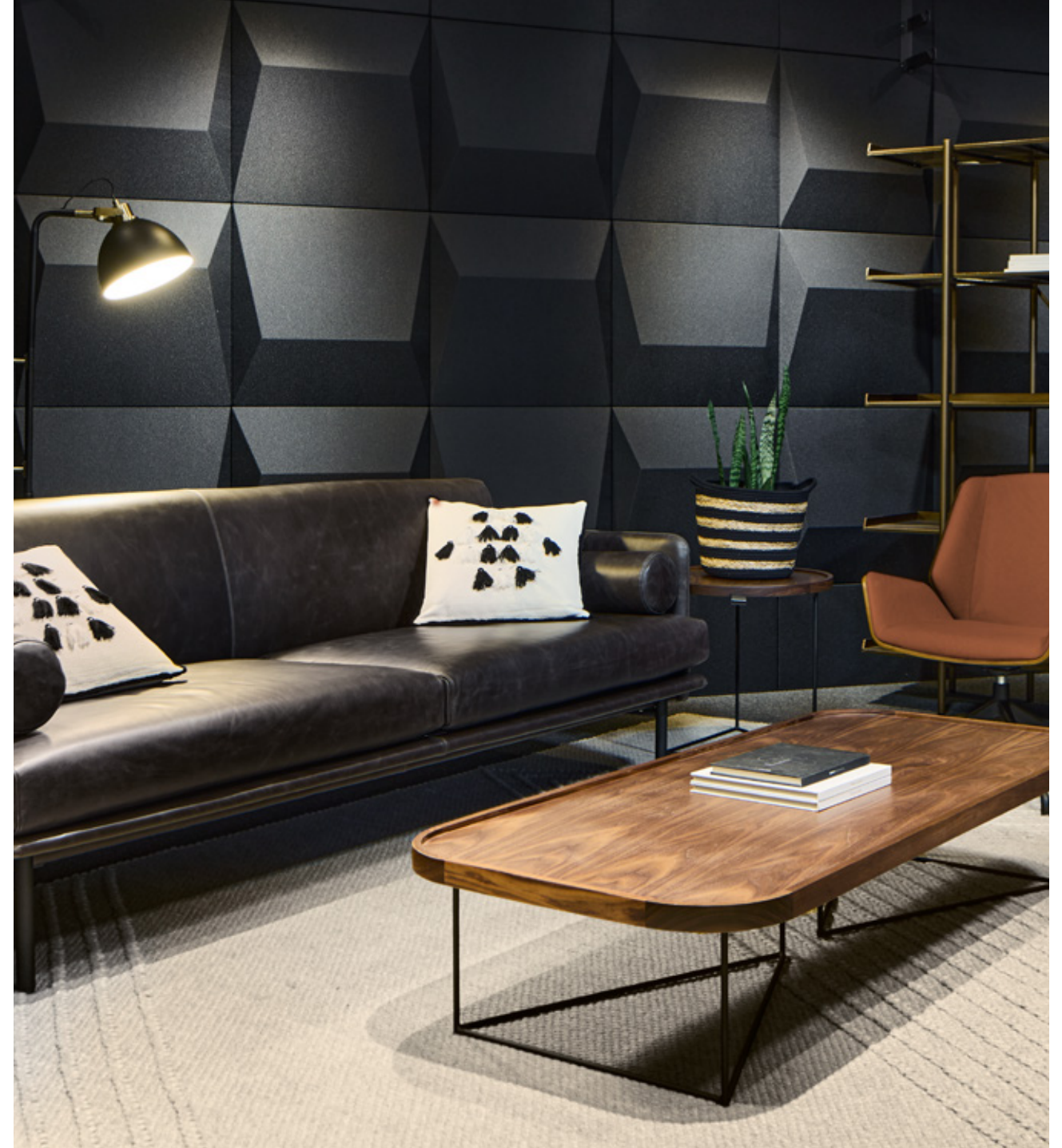

# TOPAZ

Topaz tiles can limit noise in sports facilities or eliminate distractions in collaborative workspaces. The triangular shape goes into various kinds of configurations and comes in a range of colors for endless creativity. It forms a dynamic duo with Diamond—working some magic with their contrasting volumes.



## REGULAR INSTALLATION

	Dimensions W x H	Thickness	Acoustic Surface Area	Product Code*	Walls & Ceilings	Baffles**	Clouds**
	30 x 26 in 762 x 660 m	1,3 in 33 mm	2,71 ft <sup>2</sup> 0,252 m <sup>2</sup>	TOPA-3026-R-X-****-****	●	—	●

### Perimeter Molding

	<b>Artotrim-C2</b> ARTC-2144-M-X-0000-0002	• Perimeter molding for triangular tiles
---	---	--

## SPORT-IMPACT INSTALLATION

	30 x 26 in 762 x 660 m	1,3 in 33 mm	2,71 ft <sup>2</sup> 0,252 m <sup>2</sup>	TOPA-3026-S-X-****-****	●	—	●
---	---------------------------	-----------------	--	-------------------------	---	---	---

### Perimeter Molding

	<b>Artotrim-C2</b> ARTC-2144-M-X-0000-0002	• Perimeter molding for triangular tiles
---	---	--

#### \*Fabrics

Refer to the fabric offer, section 3 of the catalogue. Replace \*\*\*\*-\*\*\*\* with the fabric-style number, followed by the selected color number.

#### \*\*Baffles and Clouds

For available formats, see pages 38 to 45.

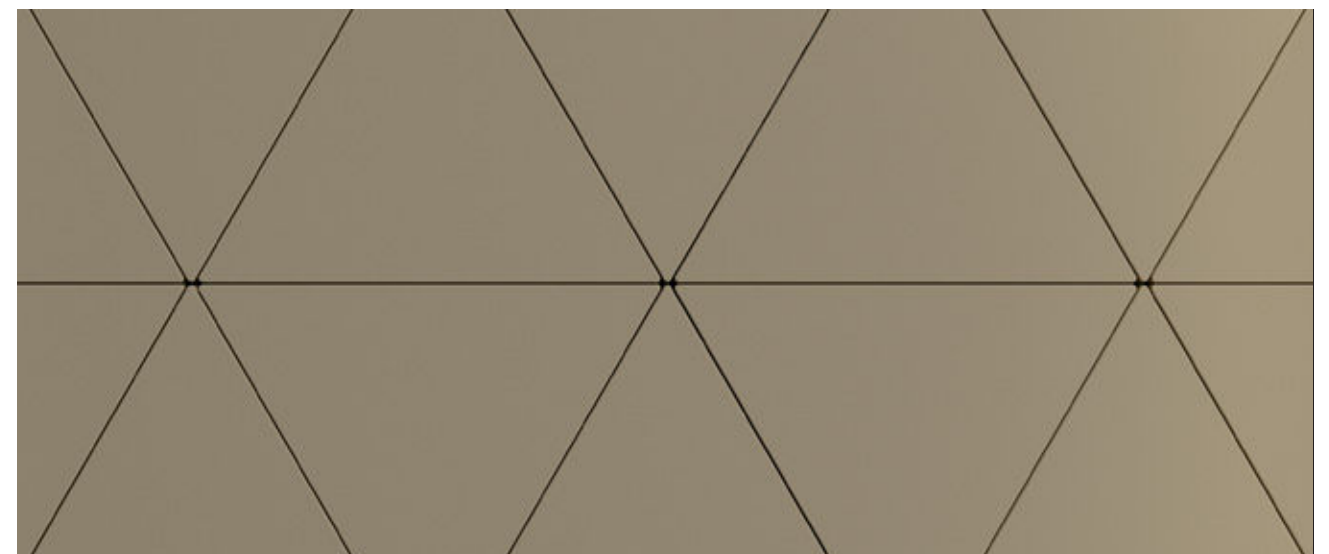

# WAVE

Wave in an alternating layout that makes a real splash at the gymnasiums! Installed horizontally it creates a gentle rocking motion that adds elegance and acoustic comfort to conference rooms and open-concept spaces alike.



## REGULAR INSTALLATION

	Dimensions W x H	Thickness	Acoustic Surface Area	Product Code*	Walls & Ceilings	Baffles**	Clouds**
	24 x 24 in 610 x 610 mm	1,3 in 33 mm	4 ft <sup>2</sup> 0,372 m <sup>2</sup>	WAVA-2424-R-X-****-****	●	—	●



### Perimeter Molding

	<b>Artotrim-C1</b> ARTC-1144-M-X-0000-0002	• Perimeter molding for full tiles
---	---	------------------------------------

## SPORT-IMPACT INSTALLATION

	22,75 x 22,75 in 578 x 578 mm	0,7 in 18 mm	3,6 ft <sup>2</sup> 0,334 m <sup>2</sup>	WAVA-2323-S-X-****-****	●	—	●
---	----------------------------------	-----------------	---	-------------------------	---	---	---

### Perimeter Moldings

	<b>Artotrim-ACG</b> ARTA-0144-M-X-0000-0002	• Perimeter molding for flat tiles, allows adjustment to wall and/or ceiling • Installed with Artotrim-L1 or Artotrim-L2 plywood finishing moldings
	<b>Artotrim-L3</b> ARTL-3024-M-X-0000-0002	• 24" angle for installation with three-dimensional tiles at the perimeters, installed with the Artotrim-ACG

#### \*Fabrics

Refer to the fabric offer, section 3 of the catalogue. Replace \*\*\*\*-\*\*\*\* with the fabric-style number, followed by the selected color number.

#### \*\*Baffles and Clouds

For available formats, see pages 38 to 45.

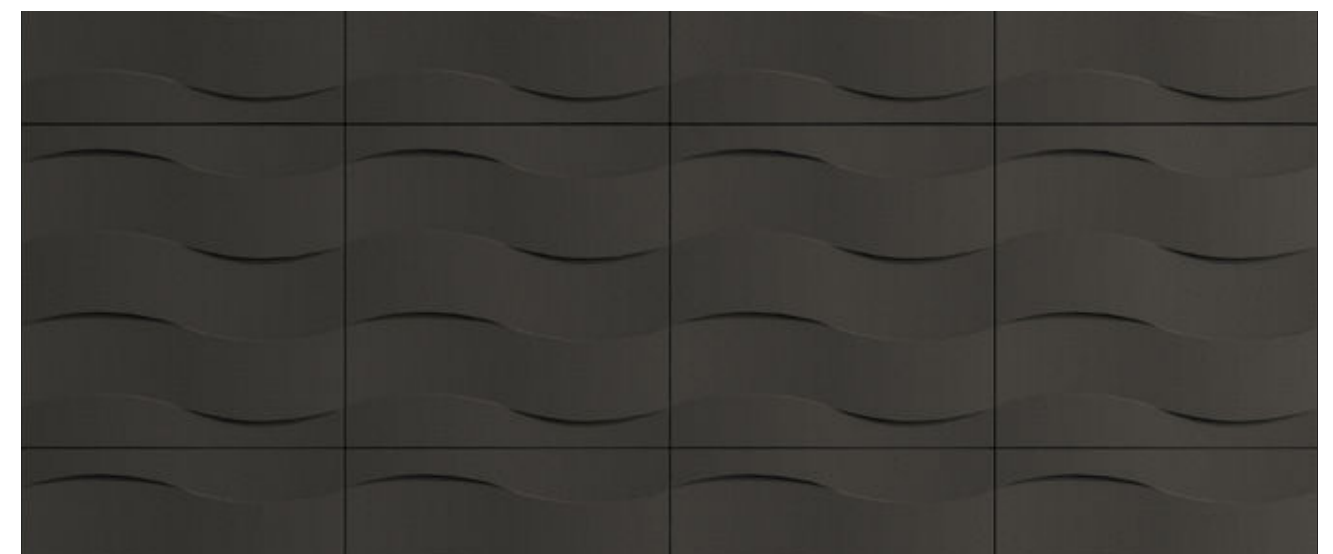

# WEDGE

Wedge's angular outline can be set in multiple directions to generate movement. There's a chaos to the shifting directions, but the overall effect is one of visual and acoustic balance and harmony. Wedge works flawlessly with Zen to expand your range of possibilities.

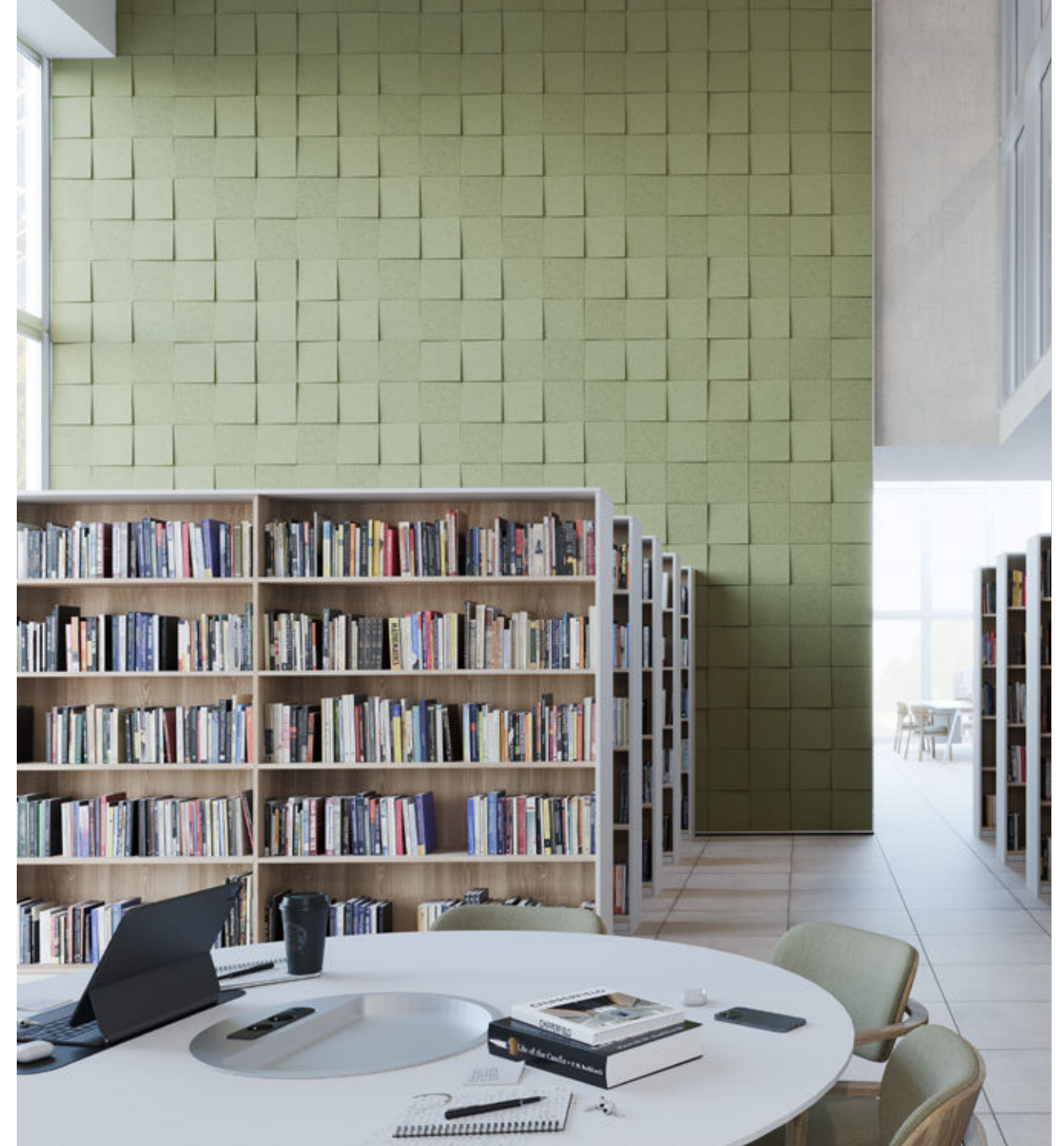

## REGULAR INSTALLATION

	Dimensions W x H	Thickness	Acoustic Surface Area	Product Code*	Walls & Ceilings	Baffles**	Clouds**
	12 x 12 in 305 x 305 mm	1,5 in 38 mm	1 ft <sup>2</sup> 0,093 m <sup>2</sup>	WEDA-1212-R-X-****-****	●	—	—

### Perimeter Molding

**Artotrim-C1**  
ARTC-1144-M-X-0000-0002 • Perimeter molding for full tiles

#### \*Fabrics

Refer to the fabric offer, section 3 of the catalogue. Replace \*\*\*\*-\*\*\*\* with the fabric-style number, followed by the selected color number.

#### \*\*Baffles and Clouds

For available formats, see pages 38 to 45.



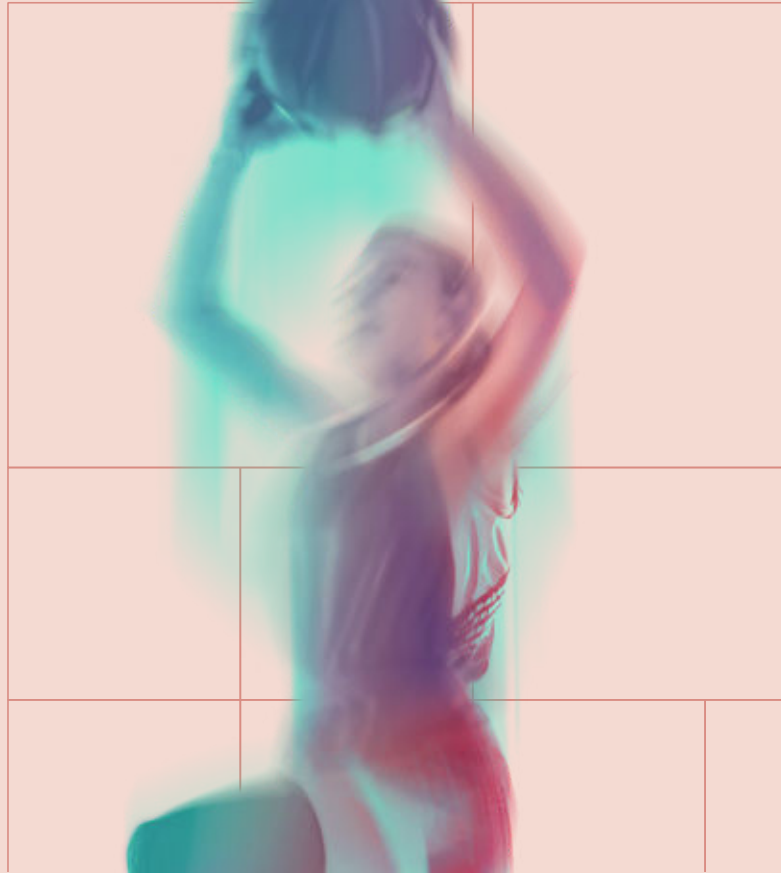

## ZEN

The Zen tile's flat profile makes it the most versatile member of the Artofix collection. Zen tiles can be applied on their own or in combination with 3D tiles to create light and shadow effects. In wall-to-wall applications they can be cut to fit the existing space.





# ZEN

## REGULAR INSTALLATION

	Dimensions W x H	Thickness	Acoustic Surface Area	Product Code*	Walls & Ceilings	Baffles**	Clouds**
	24 x 24 in 610 x 610 mm	1 in 25 mm	4 ft <sup>2</sup> 0,372 m <sup>2</sup>	ZENA-2424-R-X-****-****	●	●	●
	24 x 24 in 610 x 610 mm	0,6 in 15 mm	4 ft <sup>2</sup> 0,372 m <sup>2</sup>	ZENA-2424-T-X-****-****	●	●	●
	24 x 12 in 610 x 305 mm	1 in 25 mm	2 ft <sup>2</sup> 0,186 m <sup>2</sup>	ZENA-2412-R-X-****-****	●	●	-
	24 x 6 in 610 x 152 mm	1 in 25 mm	1 ft <sup>2</sup> 0,093 m <sup>2</sup>	ZENA-2406-R-X-****-****	●	●	-
	12 x 12 in 305 x 305 mm	1 in 25 mm	1 ft <sup>2</sup> 0,093 m <sup>2</sup>	ZENA-1212-R-X-****-****	●	-	-



### Perimeter Moldings

-  **Artotrim-C1**  
ARTC-1144-M-X-0000-0002 • Perimeter molding for full tiles
-  **Artotrim-C3**  
ARTC-3144-M-X-0000-0002 • Perimeter molding for cut Zen tiles. Allows adjustment to wall and/or ceiling  
• Finishing molding for obstacles (ex: light fixture, power outlet, electric baseboard, etc.)

## SPORT-IMPACT INSTALLATION

	24 x 24 in 610 x 610 mm	0,6 in 15 mm	4 ft <sup>2</sup> 0,372 m <sup>2</sup>	ZENA-2424-S-X-****-****	●	**	**
	22,75 x 22,75 in 578 x 578 mm	0,7 in 18 mm	3,6 ft <sup>2</sup> 0,334 m <sup>2</sup>	ZENA-2323-S-X-****-****	●	**	**
	22,75 x 11,375 in 578 x 289 mm	0,7 in 18 mm	1,8 ft <sup>2</sup> 0,167 m <sup>2</sup>	ZENA-2311-S-X-****-****	●	**	**
	11,375 x 11,375 in 289 x 289 mm	0,7 in 18 mm	3,6 ft <sup>2</sup> 0,334 m <sup>2</sup>	ZENA-1111-S-X-****-****	●	**	**

### Perimeter Moldings

-  **Artotrim-ACG**  
ARTA-0144-M-X-0000-0002 • Perimeter molding for flat tiles, allows adjustment to wall and/or ceiling  
• Installed with Artotrim-L1 or Artotrim-L2 plywood finishing moldings
-  **Artotrim-L3**  
ARTL-3024-M-X-0000-0002 • 24" angle for installation with three-dimensional tiles at the perimeters, installed with the Artotrim-ACG

#### \*Fabrics

Refer to the fabric offer, section 3 of the catalogue. Replace \*\*\*\*-\*\*\*\* with the fabric-style number, followed by the selected color number.

#### \*\*Baffles and Clouds

For available formats, see pages 38 to 45.

#### \*Thin : Moldings for full or cut Zen tiles

Artotrim-C1 only

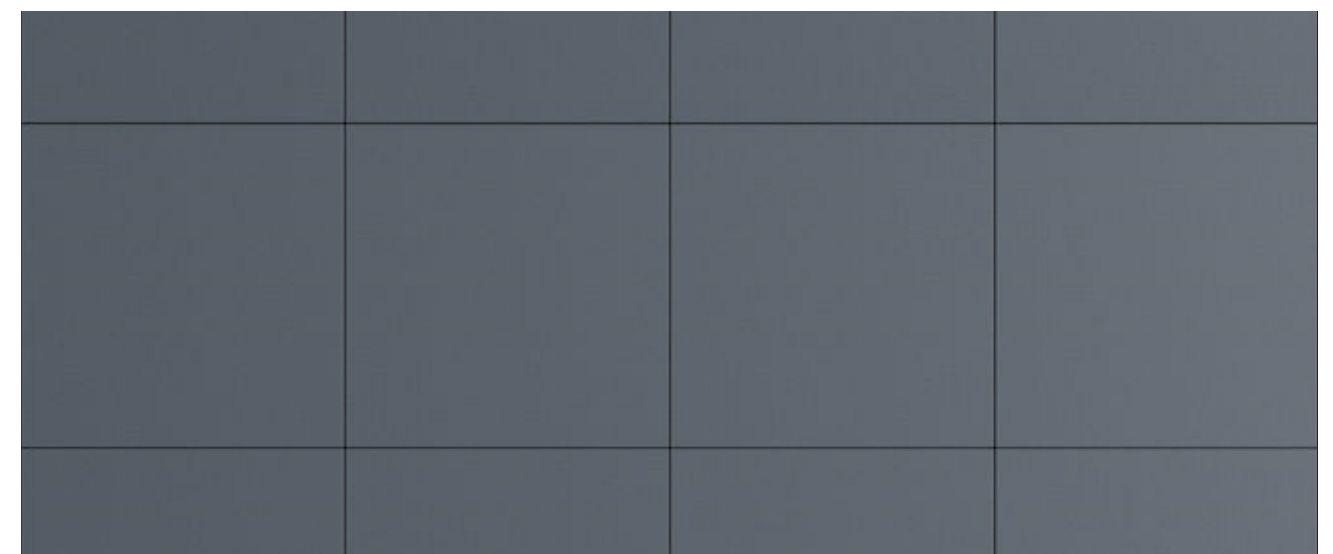

# SUSPENDED CEILING

Tiles can be hung from the ceiling using a standard grid system, or better yet, Artofix's hidden ACG\* system. In addition to wall tiles, we also offer a full lineup of acoustic tiles. The ACG system creates visual symmetry by aligning wall and ceiling tiles.

\*Artofix Concealed Grid

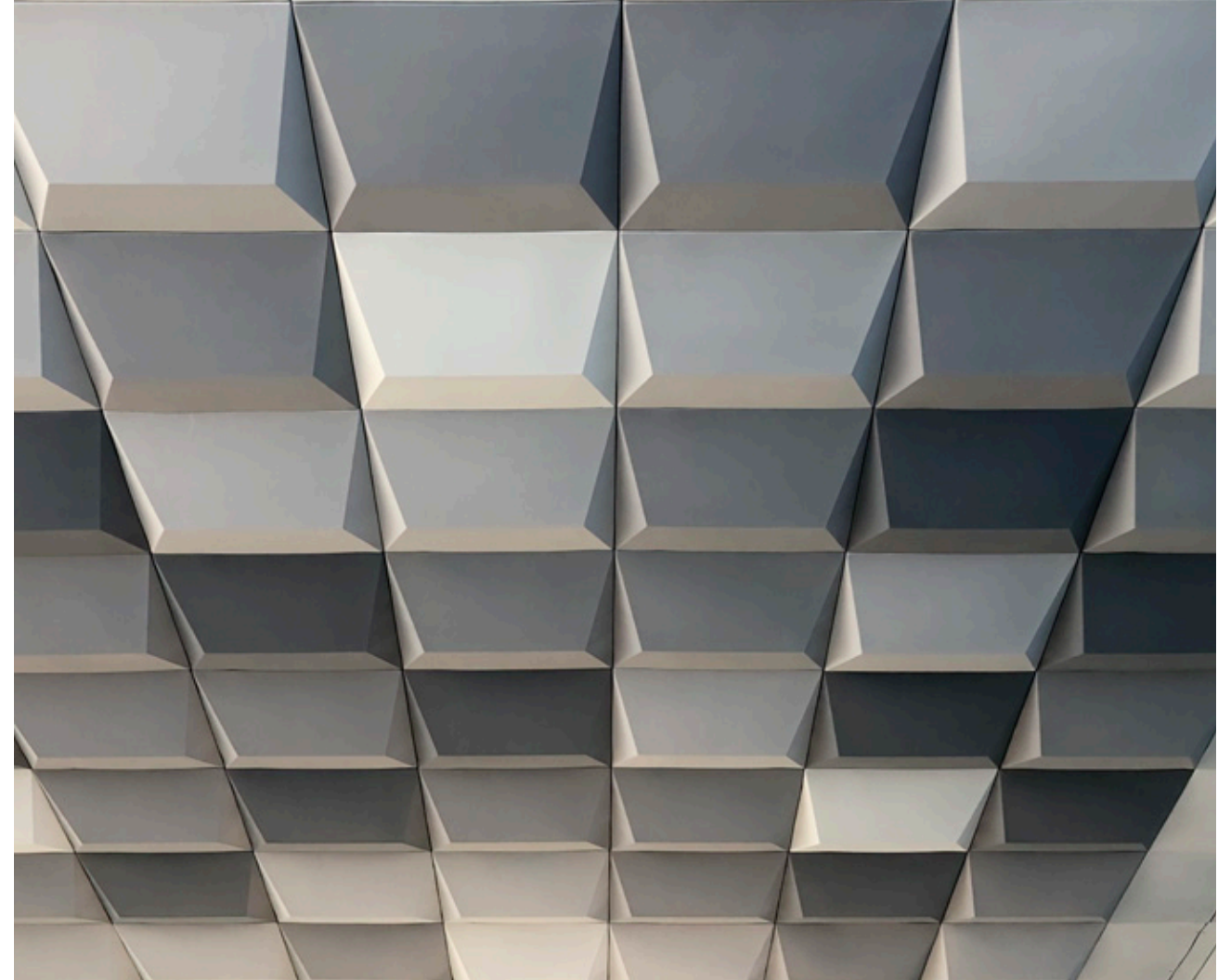
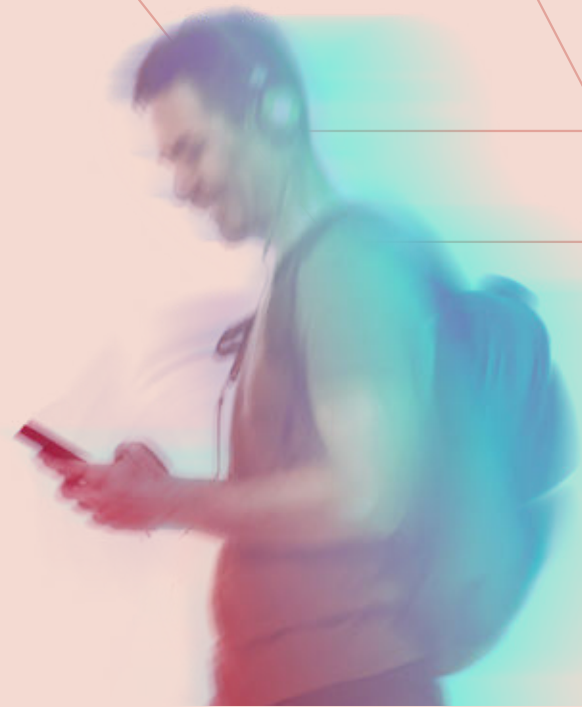





# SUSPENDED CEILING

## VISIBLE GRID SYSTEM

This system spiffs up suspended ceilings with three tile models featuring T-bar edges that fit standard 15/16-inch (24 mm) grids. Customize it to fit your room with Zen tile layouts and the addition of Artotrim-C1C finish trim.

### REGULAR INSTALLATION

Model	Dimensions W x H	Thickness	Acoustic Surface Area	Product Code*
 <b>Pulsar</b>	24 x 24 in 610 x 610 mm	3,7 in 93 mm	4 ft <sup>2</sup> 0,372 m <sup>2</sup>	PULA-2424-C-X-****-****
 <b>Wave</b>	24 x 24 in 610 x 610 mm	1,4 in 36 mm	4 ft <sup>2</sup> 0,372 m <sup>2</sup>	WAVA-2424-C-X-****-****
 <b>Zen</b>	24 x 24 in 610 x 610 mm	1,3 in 33 mm	4 ft <sup>2</sup> 0,372 m <sup>2</sup>	ZENA-2424-C-X-****-****

### Adjustment molding

- Artotrim-C1C**  
ARTC-1023-M-X-0000-0002
- Finishing molding for cut Zen tiles. Required for adjustments along the perimeter of the ceiling.

### \*Fabrics

Refer to the fabric offer, section 3 of the catalogue. Replace \*\*\*\*-\*\*\*\* with the fabric-style number, followed by the selected color number.









# SUSPENDED CEILING

## CONCEALED GRID SYSTEM

Artofix's ACG system is designed to fully cover standard 15/16-inch (24 mm) suspended-grid ceilings. Visible grids take up 8% to 10% of a suspended ceiling and their smooth, flat surfaces readily reflect sound. Not only does the ACG system improve acoustic performance—it looks better too.

### REGULAR INSTALLATION

Model	Dimensions W x H	Thickness	Acoustic Surface Area	Product Code*
 <b>Crystal</b>	24 x 24 in 610 x 610 mm	4 in 102 mm	4 ft <sup>2</sup> 0,372 m <sup>2</sup>	CRYA-2424-R-X-****-****
 <b>Prism</b>	24 x 24 in 610 x 610 mm	3,2 in 81 mm	4 ft <sup>2</sup> 0,372 m <sup>2</sup>	PRIA-2424-R-A-****-****
 <b>Pulsar</b>	24 x 24 in 610 x 610 mm	3 in 76 mm	4 ft <sup>2</sup> 0,372 m <sup>2</sup>	PULA-2424-R-A-****-****
 <b>Ruby</b>	24 x 24 in 610 x 610 mm	3,4 in 86 mm	4 ft <sup>2</sup> 0,372 m <sup>2</sup>	RUBA-2424-R-A-****-****
 <b>Wave</b>	24 x 24 in 610 x 610 mm	1,3 in 33 mm	4 ft <sup>2</sup> 0,372 m <sup>2</sup>	WAVA-2424-R-A-****-****
 <b>Zen†</b>	24 x 24 in 610 x 610 mm	0,6 in 15 mm	4 ft <sup>2</sup> 0,372 m <sup>2</sup>	ZENA-2424-T-A-****-****

### Adjustment molding



#### Artotrim-C1

ARTC-1144-M-X-0000-0002

- Perimeter molding for all full suspended ceiling tiles, including three-dimensional tiles
- Compatible with Zen (thin) tiles to allow adjustments along the ceiling perimeter or to contour obstacles (sprinklers, light fixtures, speakers, etc.)

#### \*Fabrics

Refer to the fabric offer, section 3 of the catalogue.  
Replace \*\*\*\*-\*\*\*\* with the fabric-style number, followed by the selected color number.

#### †Thin : Moldings for full or cut Zen tiles

Artotrim-C1 only



# CLOUDS & BAFFLES







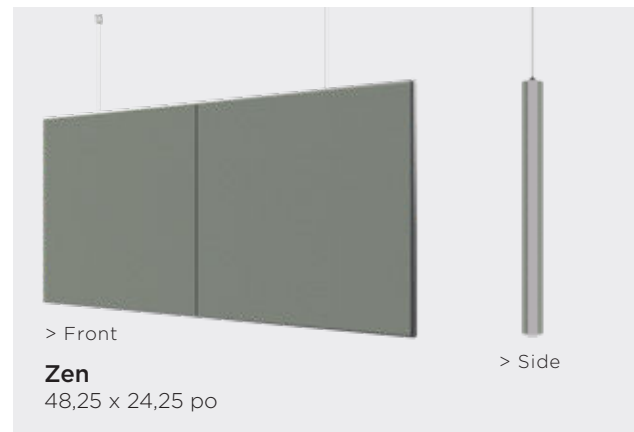
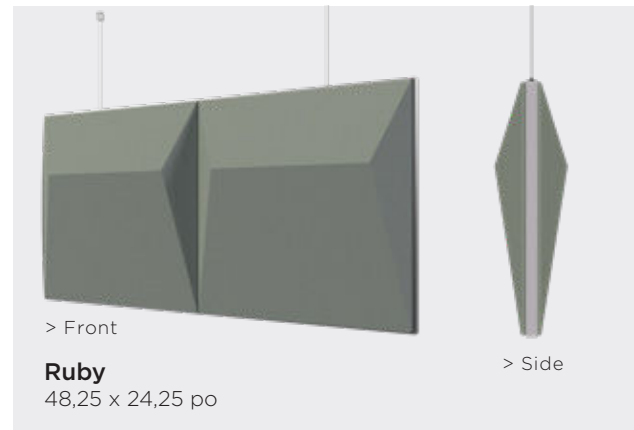
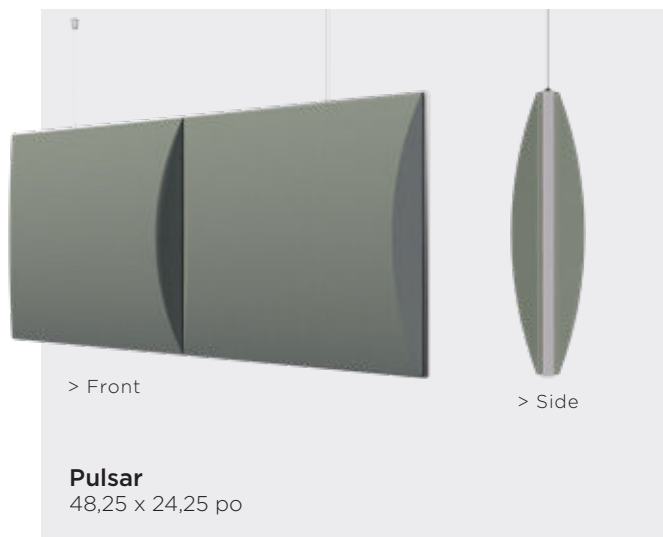
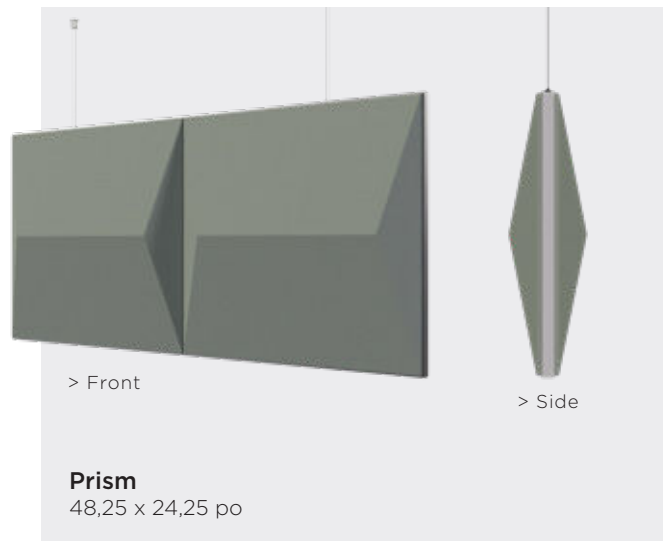



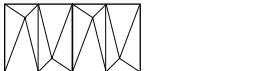
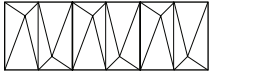
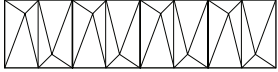
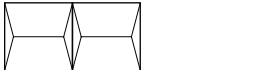

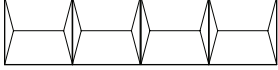

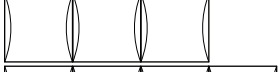
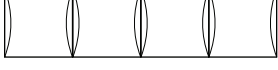
Dealing with obstructed ceilings or walls or glass partitions? Lacking surface area? Sounds like you need Artofix clouds and baffles—they'll improve your acoustics and elevate your interior. Be creative! Combine clouds and baffles with wall tiles for one-of-a-kind solutions. Baffles are easy to position around all sorts of obstacles, while clouds act as sound traps over workstations. Try layering and overlapping them and mix and match tile models and colors for dazzling results.

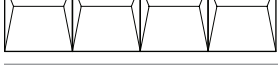

## BAFFLES

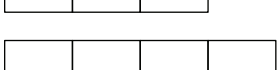

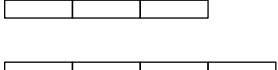
## PRODUCT INFORMATION

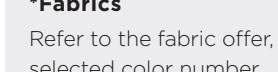
Model	Dimensions W x H	Thickness	Acoustic Surface Area	Product Code*
<b>Crystal</b>	 48,25 x 24,25 in 1225 x 645 mm	8,25 in 210 mm	16 ft <sup>2</sup> 1,486 m <sup>2</sup>	CRYA-4824-R-B-****-****
	 72,25 x 24,25 in 1835 x 645 mm	8,25 in 210 mm	24 ft <sup>2</sup> 2,230 m <sup>2</sup>	CRYA-7224-R-B-****-****
	 96,25 x 24,25 in 2445 x 645 mm	8,25 in 210 mm	32 ft <sup>2</sup> 2,973 m <sup>2</sup>	CRYA-9624-R-B-****-****
<b>Prism</b>	 48,25 x 24,25 in 1225 x 645 mm	6,65 in 169 mm	16 ft <sup>2</sup> 1,486 m <sup>2</sup>	PRIA-4824-R-B-****-****
	 72,25 x 24,25 in 1835 x 645 mm	6,65 in 169 mm	24 ft <sup>2</sup> 2,230 m <sup>2</sup>	PRIA-7224-R-B-****-****
	 96,25 x 24,25 in 2445 x 645 mm	6,65 in 169 mm	32 ft <sup>2</sup> 2,973 m <sup>2</sup>	PRIA-9624-R-B-****-****
<b>Pulsar</b>	 48,25 x 24,25 in 1225 x 645 mm	6,25 in 159 mm	16 ft <sup>2</sup> 1,486 m <sup>2</sup>	PULA-4824-R-B-****-****
	 72,25 x 24,25 in 1835 x 645 mm	6,25 in 159 mm	24 ft <sup>2</sup> 2,230 m <sup>2</sup>	PULA-7224-R-B-****-****
	 96,25 x 24,25 in 2445 x 645 mm	6,25 in 159 mm	32 ft <sup>2</sup> 2,973 m <sup>2</sup>	PULA-9624-R-B-****-****
<b>Ruby</b>	 48,25 x 24,25 in 1225 x 645 mm	7,05 in 179 mm	16 ft <sup>2</sup> 1,486 m <sup>2</sup>	RUBA-4824-R-B-****-****
	 72,25 x 24,25 in 1835 x 645 mm	7,05 in 179 mm	24 ft <sup>2</sup> 2,230 m <sup>2</sup>	RUBA-7224-R-B-****-****
	 96,25 x 24,25 in 2445 x 645 mm	7,05 in 179 mm	32 ft <sup>2</sup> 2,973 m <sup>2</sup>	RUBA-9624-R-B-****-****
<b>Zen</b>	 48,25 x 24,25 in 1225 x 645 mm	2,25 in 57 mm	16 ft <sup>2</sup> 1,486 m <sup>2</sup>	ZENA-4824-R-B-****-****
	 72,25 x 24,25 in 1835 x 645 mm	2,25 in 57 mm	24 ft <sup>2</sup> 2,230 m <sup>2</sup>	ZENA-7224-R-B-****-****
	 96,25 x 24,25 in 2445 x 645 mm	2,25 in 57 mm	32 ft <sup>2</sup> 2,973 m <sup>2</sup>	ZENA-9624-R-B-****-****
	 48,25 x 12,25 in 1225 x 311 mm	2,25 in 57 mm	8 ft <sup>2</sup> 0,743 m <sup>2</sup>	ZENA-4812-R-B-****-****
	 72,25 x 12,25 in 1835 x 311 mm	2,25 in 57 mm	12 ft <sup>2</sup> 1,115 m <sup>2</sup>	ZENA-7212-R-B-****-****
	 96,25 x 12,25 in 2445 x 311 mm	2,25 in 57 mm	16 ft <sup>2</sup> 1,486 m <sup>2</sup>	ZENA-9612-R-B-****-****
<b>Zen</b>	 48,25 x 6,25 in 1225 x 159 mm	2,25 in 57 mm	4 ft <sup>2</sup> 0,372 m <sup>2</sup>	ZENA-4806-R-B-****-****
	 72,25 x 6,25 in 1835 x 159 mm	2,25 in 57 mm	6 ft <sup>2</sup> 0,557 m <sup>2</sup>	ZENA-7206-R-B-****-****
	 96,25 x 6,25 in 2445 x 159 mm	2,25 in 57 mm	8 ft <sup>2</sup> 0,743 m <sup>2</sup>	ZENA-9606-R-B-****-****

**\*Fabrics**



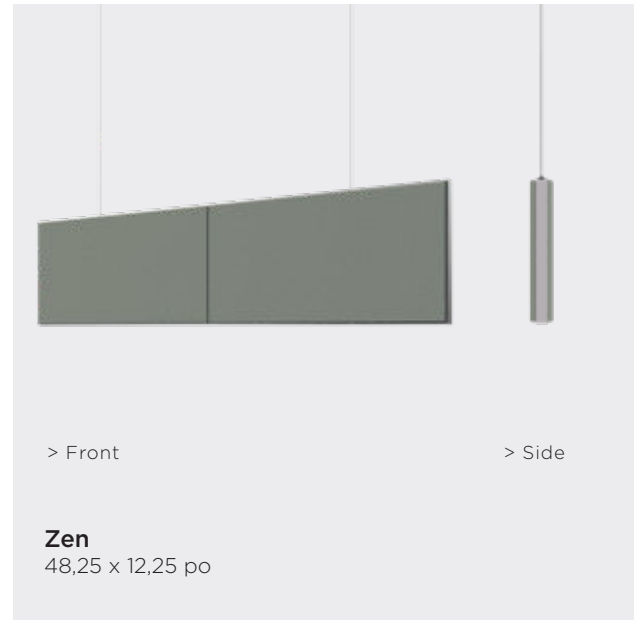

Refer to the fabric offer, section 3 of the catalogue. Replace \*\*\*\*-\*\*\*\* with the fabric-style number, followed by the selected color number.

# BAFFLES

## SPORT-IMPACT

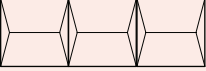

### PRODUCT INFORMATION

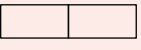
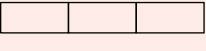
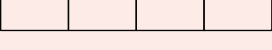
	Model	Dimensions W x H	Thickness	Acoustic Surface Area	Product Code*
	<b>Prism</b>	48,25 x 24,25 in 1225 x 645 mm	6,65 in 169 mm	16 ft <sup>2</sup> 1,486 m <sup>2</sup>	PRIA-4824-S-B-****-****
		72,25 x 24,25 in 1835 x 645 mm	6,65 in 169 mm	24 ft <sup>2</sup> 2,230 m <sup>2</sup>	PRIA-7224-S-B-****-****
		96,25 x 24,25 in 2445 x 645 mm	6,65 in 169 mm	32 ft <sup>2</sup> 2,973 m <sup>2</sup>	PRIA-9624-S-B-****-****
	<b>Zen</b>	48,25 x 24,25 in 1225 x 645 mm	2,25 in 57 mm	16 ft <sup>2</sup> 1,486 m <sup>2</sup>	ZENA-4824-S-B-****-****
		72,25 x 24,25 in 1835 x 645 mm	2,25 in 57 mm	24 ft <sup>2</sup> 2,230 m <sup>2</sup>	ZENA-7224-S-B-****-****
		96,25 x 24,25 in 2445 x 645 mm	2,25 in 57 mm	32 ft <sup>2</sup> 2,973 m <sup>2</sup>	ZENA-9624-S-B-****-****
		48,25 x 12,25 in 1225 x 311 mm	2,25 in 57 mm	8 ft <sup>2</sup> 0,743 m <sup>2</sup>	ZENA-4812-S-B-****-****
		72,25 x 12,25 in 1835 x 311 mm	2,25 in 57 mm	12 ft <sup>2</sup> 1,115 m <sup>2</sup>	ZENA-7212-S-B-****-****
		96,25 x 12,25 in 2445 x 311 mm	2,25 in 57 mm	16 ft <sup>22</sup> 1,486 m <sup>2</sup>	ZENA-9612-S-B-****-****

#### \*Fabrics

Refer to the fabric offer, section 3 of the catalogue. Replace \*\*\*\*-\*\*\*\* with the fabric-style number, followed by the selected color number.

# CLOUDS



**Crystal**  
48,25 x 48,25 in



**Topaz**  
52,25 x 52,25 in



**Prism**  
48,25 x 48,25 in

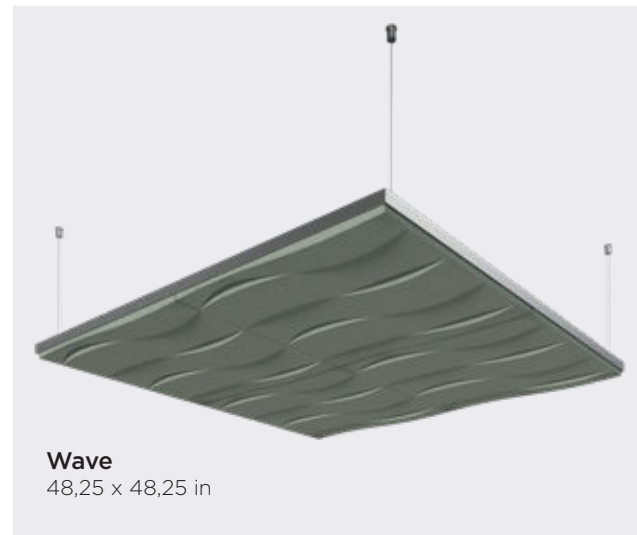

**Wave**  
48,25 x 48,25 in



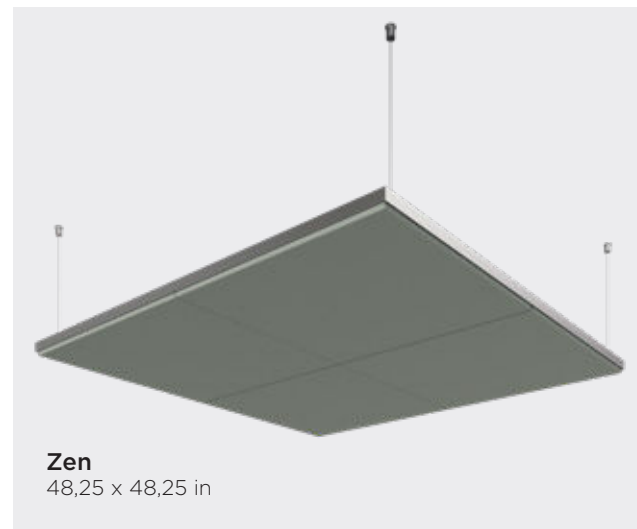

**Pulsar**  
48,25 x 48,25 in

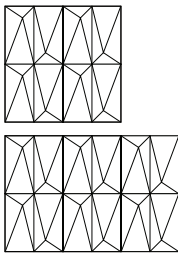
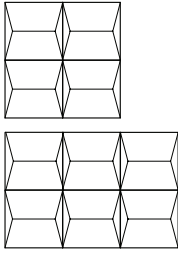
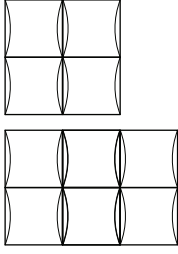

**Zen**  
48,25 x 48,25 in

## PRODUCT INFORMATION

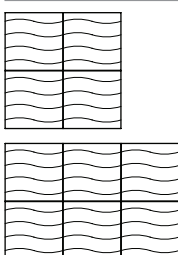
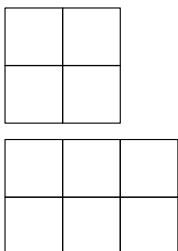
Model	Dimensions W x H	Thickness	Acoustic Surface Area	Product Code*
	48,25 x 48,25 in 1225 x 1225 mm	4,25 in 108 mm	16 ft <sup>2</sup> 1,486 m <sup>2</sup>	CRYA-4848-R-N-****-****
	48,25 x 72,25 in 1225 x 1835 mm	4,25 in 108 mm	24 ft <sup>2</sup> 2,230 m <sup>2</sup>	CRYA-4872-R-N-****-****
	48,25 x 48,25 in 1225 x 1225 mm	3,45 in 88 mm	16 ft <sup>2</sup> 1,486 m <sup>2</sup>	PRIA-4848-R-N-****-****
	48,25 x 72,25 in 1225 x 1835 mm	3,45 in 88 mm	24 ft <sup>2</sup> 2,230 m <sup>2</sup>	PRIA-4872-R-N-****-****
	48,25 x 48,25 in 1225 x 1225 mm	3,25 in 83 mm	16 ft <sup>2</sup> 1,486 m <sup>2</sup>	PULA-4848-R-N-****-****
	48,25 x 72,25 po 1225 x 1835 mm	3,25 po 83 mm	24 ft <sup>2</sup> 2,230 m <sup>2</sup>	PULA-4872-R-N-****-****
	52,25 x 52,25 in 1327 x 1327 mm	1,55 in 39 mm	16,26 ft <sup>2</sup> 1,511 m <sup>2</sup>	TOPA-5252-R-N-****-****
	48,25 x 48,25 in 1225 x 1225 mm	1,25 in 32 mm	16 ft <sup>2</sup> 1,486 m <sup>2</sup>	WAVA-4848-R-N-****-****
	48,25 x 72,25 in 1225 x 1835 mm	1,25 in 32 mm	24 ft <sup>2</sup> 2,230 m <sup>2</sup>	WAVA-4872-R-N-****-****
	48,25 x 48,25 in 1225 x 1225 mm	1,25 in 32 mm	16 ft <sup>2</sup> 1,486 m <sup>2</sup>	ZENA-4848-R-N-****-****
	48,25 x 72,25 in 1225 x 1835 mm	1,25 in 32 mm	24 ft <sup>2</sup> 2,230 m <sup>2</sup>	ZENA-4872-R-N-****-****

**\*Fabrics**

Refer to the fabric offer, section 3 of the catalogue. Replace \*\*\*\*-\*\*\*\* with the fabric-style number, followed by the selected color number.

# CLOUDS SPORT-IMPACT

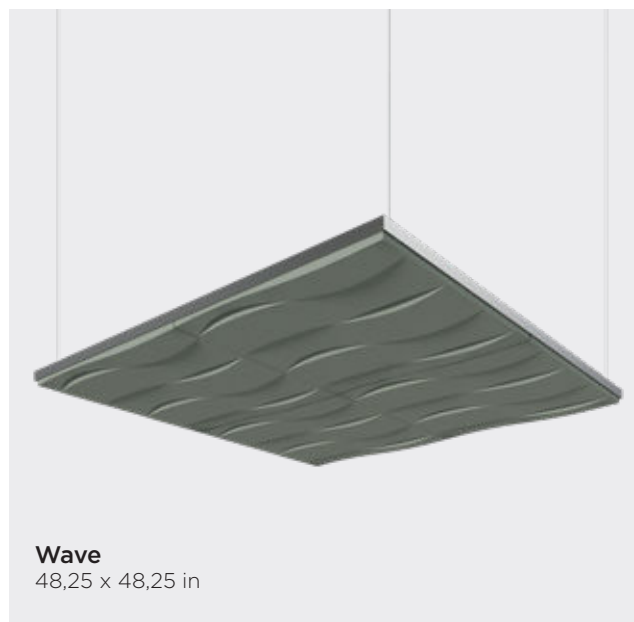

## PRODUCT INFORMATION

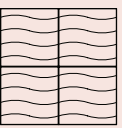
Model	Dimensions W x H	Thickness	Acoustic Surface Area	Product Code*
 <b>Prism</b>	48,25 x 48,25 in 1225 x 1225 mm	3,45 in 88 mm	16 ft <sup>2</sup> 1,486 m <sup>2</sup>	PRIA-4848-S-N-****-****
	48,25 x 72,25 in 1225 x 1835 mm	3,45 in 88 mm	24 ft <sup>2</sup> 2,230 m <sup>2</sup>	PRIA-4872-S-N-****-****
 <b>Topaz</b>	52,25 x 52,25 in 1327 x 1327 mm	1,55 in 39 mm	16,26 ft <sup>2</sup> 1,511 m <sup>2</sup>	TOPA-5252-S-N-****-****
 <b>Wave</b>	48,25 x 48,25 in 1225 x 1225 mm	1,25 in 32 mm	16 ft <sup>2</sup> 1,486 m <sup>2</sup>	WAVA-4848-S-N-****-****
	48,25 x 72,25 in 1225 x 1835 mm	1,25 in 32 mm	24 ft <sup>2</sup> 2,230 m <sup>2</sup>	WAVA-4872-S-N-****-****
 <b>Zen</b>	48,25 x 48,25 in 1225 x 1225 mm	1,25 in 32 mm	16 ft <sup>2</sup> 1,486 m <sup>2</sup>	ZENA-4848-S-N-****-****
	48,25 x 72,25 in 1225 x 1835 mm	1,25 in 32 mm	24 ft <sup>2</sup> 2,230 m <sup>2</sup>	ZENA-4872-S-N-****-****

**\*Fabrics**

Refer to the fabric offer, section 3 of the catalogue. Replace \*\*\*\*-\*\*\*\* with the fabric-style number, followed by the selected color number.

# 03

Specifications

# FABRICS



# ANCHORAGE 2335

						
<b>Slate</b> 2017	<b>White</b> 2664	<b>Birch</b> 2129	<b>Vanilla</b> 2130			
						
	<b>Shadow</b> 6694	<b>Angora</b> 2035	<b>Goose</b> 2049			
						
<b>Coffee Bean</b> 2083	<b>Graphite</b> 2079	<b>Onyx</b> 2016	<b>Midnight</b> 2025	<b>Cobalt</b> 2045	<b>Lapis</b> 2094	<b>Thistle</b> 2085
						
<b>Pine Needle</b> 2022	<b>Deep Water</b> 2051	<b>Waterfall</b> 2691	<b>Asteroid</b> 2053	<b>Wolf</b> 2027	<b>Quarry Blue</b> 2026	<b>Pool</b> 2842
						
<b>Turquoise</b> 2841	<b>Fern</b> 2840	<b>Willow</b> 2028	<b>Green Apple</b> 2087	<b>Eucalyptus</b> 2047	<b>Cumin</b> 2050	<b>Straw</b> 2034
						
<b>Red Delicious</b> 2014	<b>Geranium</b> 2084	<b>Poppy</b> 2091	<b>Pumpkin</b> 2021	<b>Lemon</b> 2839	<b>Sunshine</b> 2082	<b>Goldenrod</b> 2090
						
<b>Mulberry</b> 2044	<b>Orchid</b> 2843	<b>Aubergine</b> 2036	<b>Fossil</b> 2093			

\*Colors may vary from the physical fabrics. To order samples, please contact your sales representative or your authorized distributor.



# MARIN 1300



**Dolphin**  
1147

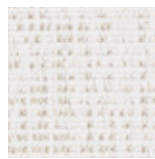

**Great White**  
1143



**Ice Edge**  
1145



**Sea Glass**  
1146

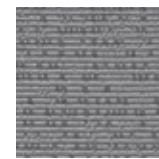

**Grey Whale**  
1148



**Sand**  
1142



**Pelican**  
1141



**Tusk**  
1144



**Swell**  
1155



**Benthic**  
1157

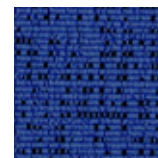

**Intertidal**  
1156



**Blacktip**  
1149



**Carrageen**  
1150



**Red Snapper**  
1151

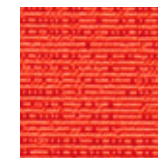

**Clownfish**  
1152



**Mangrove**  
1154



**Sunfish**  
1153

# QUADRILLE 4701

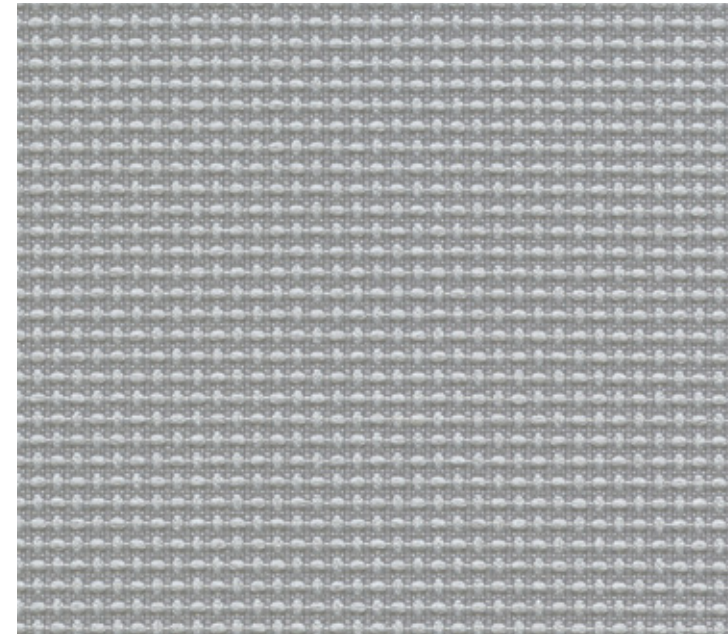

**Gambol**  
1003



**Cabaret**  
1002



**Fair**  
1001

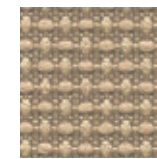

**Leisure**  
1004

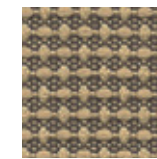

**Regalia**  
1005

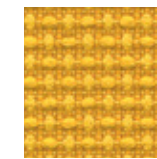

**Zest**  
1007

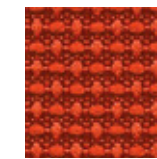

**Fiesta**  
1008



**Carnival**  
1009



**Shenanigan**  
1017

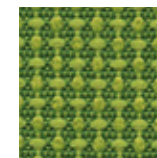

**Spring**  
1006

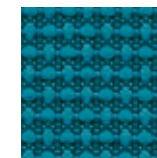

**Escapade**  
1016



**Revelry**  
1015

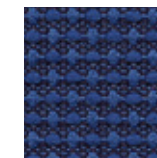

**Soiree**  
1014

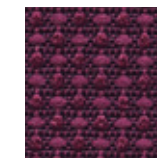

**Jubilee**  
1011

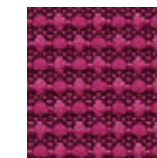

**Spree**  
1010



**Opus**  
1012

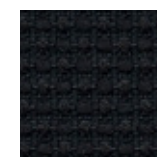

**Masquerade**  
1013

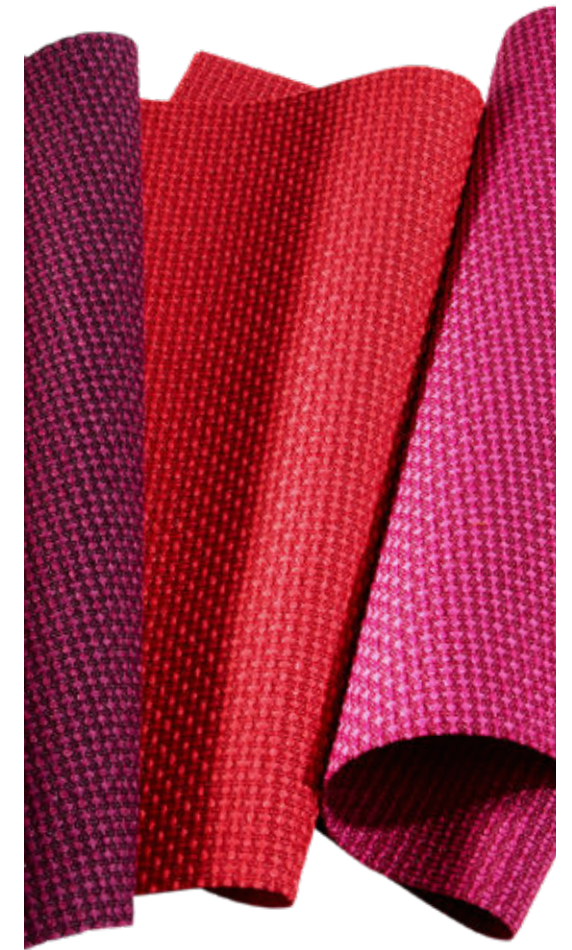

# WHISPER 1240

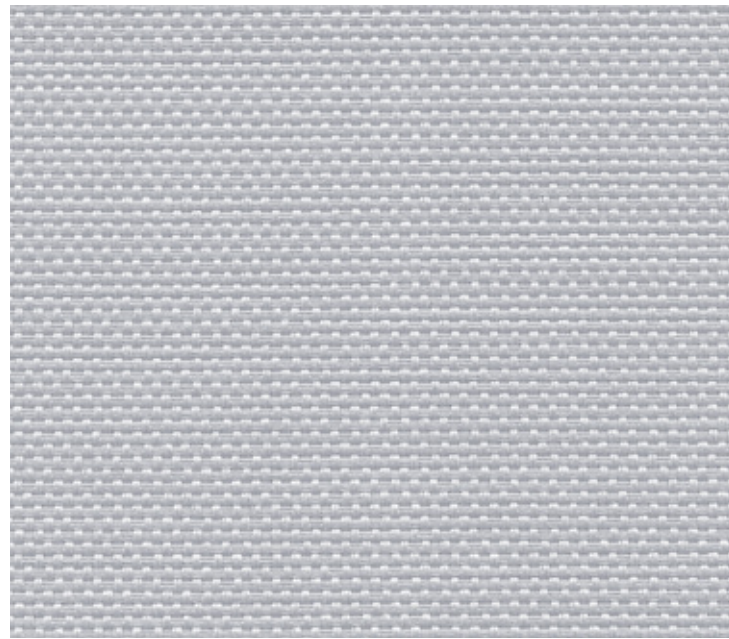

**Tranquility**  
1280

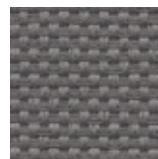

**Serenity**  
1285

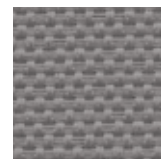

**Quiet**  
1286



**Zen**  
1282



**Ambience**  
1278



**Hush**  
1281

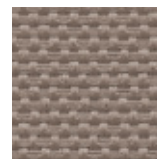

**Mute**  
1284

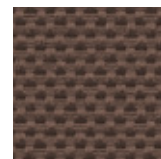

**Muffle**  
1287

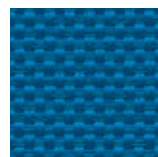

**Placid**  
1294

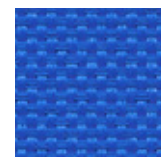

**Secret**  
1296

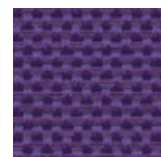

**Mystery**  
1299

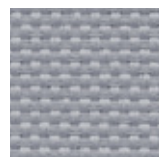

**Stillness**  
1283

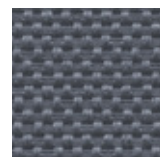

**Lull**  
1289

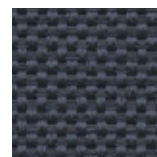

**Cloud**  
1288

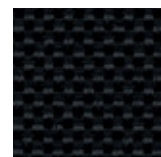

**Shadow**  
1300

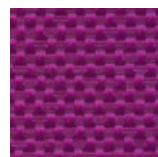

**Mum**  
1297

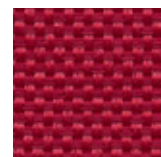

**Chant**  
1295

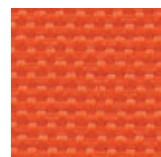

**Mellow**  
1293

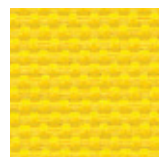

**Peep**  
1291

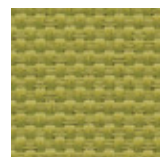

**Reserve**  
1290

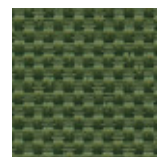

**Baffle**  
1292



**Spirit**  
8888

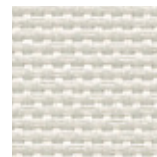

**Dim**  
1276

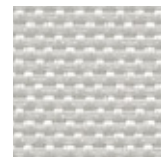

**Silence**  
1279



# FELTINA® 1000



**Smoke**  
1005



**Ash**  
1002



**Pebble**  
1009



**Iron**  
1007

## MOLDINGS



Artotrim-C1



Artotrim-C2



Artotrim-C3



Artotrim-ACG

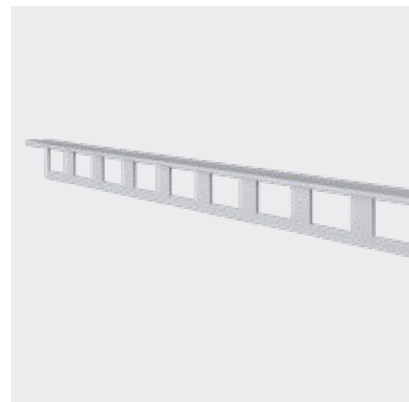

Artotrim-L1

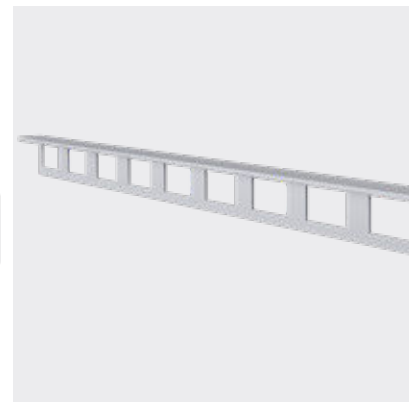

Artotrim-L2



Artotrim-L3

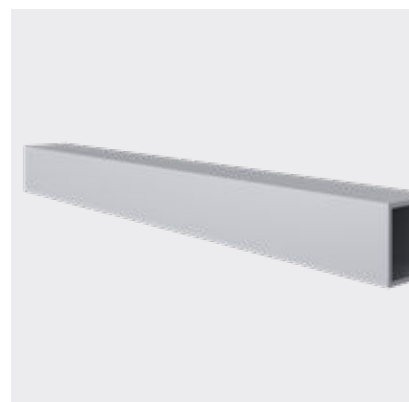

Artotrim-SQ1



Artotrim-SQ2

## PRODUCT INFORMATION

Model	Length	Code	Description & Application
<b>MOLDINGS FOR REGULAR INSTALLATION</b>			
Artotrim-C1	144 in 3658 mm	ARTC-1144-M-X-0000-0002	<ul style="list-style-type: none"> <li>Perimeter molding for full tiles, including three-dimensional tiles</li> </ul>
Artotrim-C2	144 in 3658 mm	ARTC-2144-M-X-0000-0002	<ul style="list-style-type: none"> <li>Perimeter molding for triangular tiles (Topaz and Diamond)</li> </ul>
Artotrim-C3	144 in 3658 mm	ARTC-3144-M-X-0000-0002	<ul style="list-style-type: none"> <li>Perimeter molding for cut Zen tiles. Allows adjustment to wall and/or ceiling</li> <li>Finishing molding for obstacles (ex: light fixture, power outlet, electric baseboard, etc.)</li> </ul>
<b>MOLDINGS FOR SPORT-IMPACT INSTALLATION</b>			
Artotrim-ACG	144 in 3658 mm	ARTA-0144-M-X-0000-0002	<ul style="list-style-type: none"> <li>Perimeter molding for flat tiles, Allows adjustment to wall and/or ceiling</li> <li>Installed with Artotrim-L1 or Artotrim-L2 plywood finishing molding</li> </ul>
Artotrim-L3	24 in 610 mm	ARTL-3024-M-X-0000-0002	<ul style="list-style-type: none"> <li>24" angle for installation with three-dimensional tiles at the perimeters, installed with the Artotrim-ACG</li> </ul>
Artotrim-C2	144 in 3658 mm	ARTC-2144-M-X-0000-0002	<ul style="list-style-type: none"> <li>Perimeter molding for triangular tiles (Topaz and Diamond)</li> </ul>
<b>MOLDINGS SUSPENDED CEILING INSTALLATION (Exposed grid)</b>			
Artotrim-C1C*	23,75 in 610 mm	ARTC-1023-M-X-0000-0002	<ul style="list-style-type: none"> <li>Finishing molding for cut Zen tiles. Required for adjustments along the perimeter of the ceiling.</li> </ul>
Artotrim-C1C* Convex kit		ARTC-1001-M-C-0000-0002	<ul style="list-style-type: none"> <li>Interior corner finishing molding for Zen suspended ceiling tiles</li> </ul>
Artotrim-C1C* Convex kit		ARTC-1002-M-C-0000-0002	<ul style="list-style-type: none"> <li>Exterior corner finishing molding for Zen suspended ceiling tiles</li> </ul>
<b>MOLDING FOR SUSPENDED CEILING INSTALLATION (ACG concealed grid)</b>			
Artotrim-C1	144 in 3658 mm	ARTC-1144-M-X-0000-0002	<ul style="list-style-type: none"> <li>Perimeter molding for all full suspended ceiling tiles, including three-dimensional tiles</li> <li>Compatible with Zen (thin) tiles to allow adjustments along the ceiling perimeter or to contour obstacles (sprinklers, light fixtures, speakers, etc.)</li> </ul>
<b>OTHER MOLDINGS</b>			
Artotrim-L1	96 in 2438 mm	ARTL-1096-M-X-0000-0002	<ul style="list-style-type: none"> <li>Finishing molding for 1/2 in plywood backing</li> </ul>
Artotrim-L2	96 in 2438 mm	ARTL-2096-M-X-0000-0002	<ul style="list-style-type: none"> <li>Finishing molding for 5/8 in plywood backing</li> </ul>
Artotrim-SQ1	144 in 3658 mm	ARTS-1144-M-X-0000-0002	<ul style="list-style-type: none"> <li>3/4 in x 3/4 in square tube for inner and outer corners</li> <li>Compatible with Artotrim-C1 molding</li> </ul>
Artotrim-SQ2	144 in 3658 mm	ARTS-2144-M-X-0000-0002	<ul style="list-style-type: none"> <li>1 in x 1 in square tube for inner and outer corners. Compatible with Artotrim-C3 molding</li> </ul>

Finish: Anodized aluminium. Black and white finishes are optional.

\*Colors may vary from physical fabrics.

# ARTOFIX

662, 9<sup>e</sup> avenue  
Beauceville, Qc G5X 1C6  
418 227-9897

[artofix.com](http://artofix.com)

